



ROTARY INSTRUMENTS

SAW BLADES

INTRA ORAL BLADES

RASPS



CREATE IT.

Feel the difference

Made in Japan, Primado2 is NSK's second generation high speed total surgical system developed to keep up with demand from surgeons.

Since the launch of the first generation of Primado in 2006, we have been working with surgeons across the world. Their needs and requests gave shape to the new Primado2 which we created with balance, power, and a lightweight design to prevent stress from long operating hours.

We invite you to experience Primado2 – the next evolution of high speed drills.

Primado

— series —

CUTTING ACCESSORIES

Feel the difference

Made in Japan, Primado2 is NSK's second generation high speed total surgical system developed to keep up with demand from surgeons.

Since the launch of the first generation of Primado in 2006, we have been working with surgeons across the world. Their needs and requests gave shape to the new Primado2 which we created with balance, power, and a lightweight design to prevent stress from long operating hours.

We invite you to experience Primado2 – the next evolution of high speed drills.

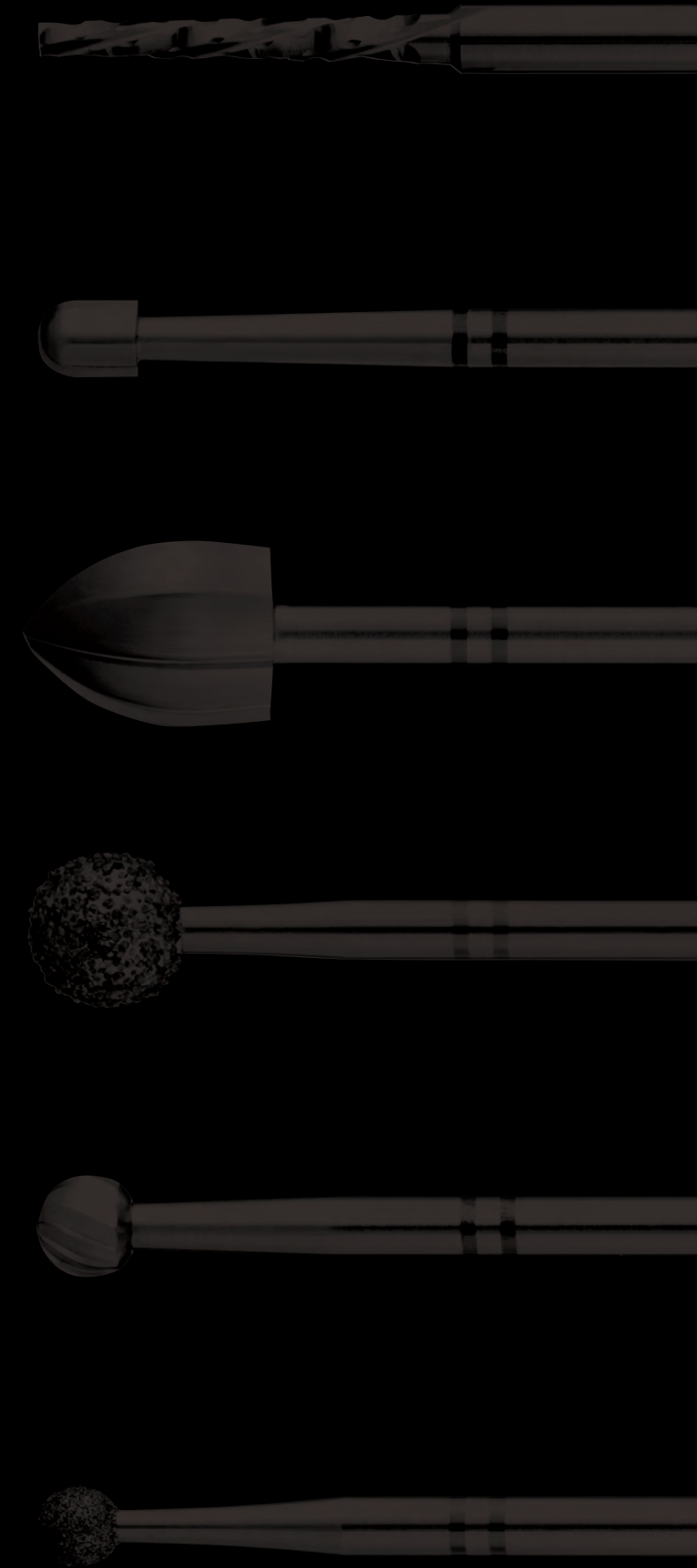

ROTARY INSTRUMENTS $\varnothing 1.0\text{ mm}$

Diamond Burs

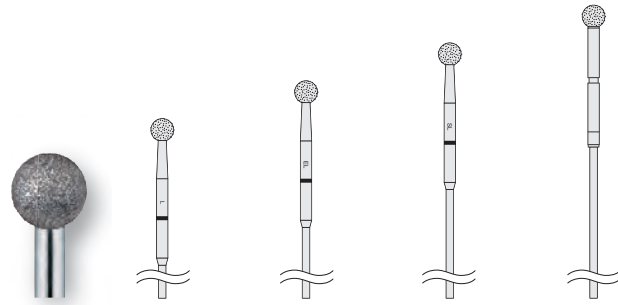

Head Size	Long	Extra Long	Super Long	Special Long
	for P200-1A135 PD-1A135	for P200-1A155 P200-1A155-C PD-1A155-10	for P200-1A175 P200-1A175-C PD-1A175-10	for P200-RA330 PD-RA330
2.0	PDS-1D135-20	PDS-1D155-20	PDS-1D175-20	PDS-1D330-20
2.5	—	—	—	PDS-1D330-25
3.0	PDS-1D135-30	PDS-1D155-30	PDS-1D175-30	PDS-1D330-30
3.5	—	—	—	PDS-1D330-35
4.0	PDS-1D135-40	PDS-1D155-40	PDS-1D175-40	—

Coarse Diamond Burs

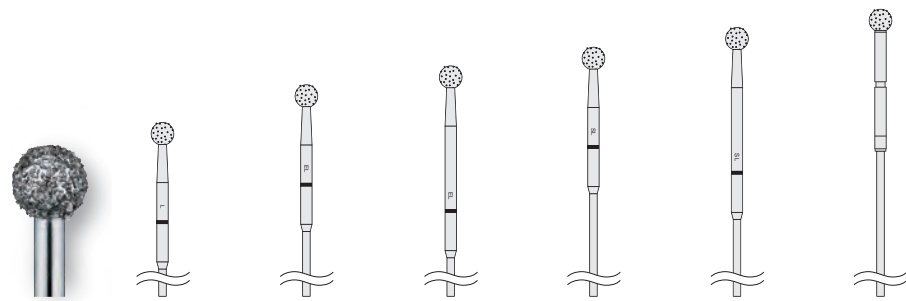

Head Size	Long	Extra Long	Extra Long [Extended]	Super Long	Super Long [Extended]	Special Long
	for P200-1A135 PD-1A135	for P200-1A155 P200-1A155-C PD-1A155-10	for P200-1A155 P200-1A155-C PD-1A155-10	for P200-1A175 P200-1A175-C PD-1A175-10	for P200-1A175 P200-1A175-C PD-1A175-10	for P200-RA330 PD-RA330
2.0	PDS-1CD135-20	PDS-1CD155-20	PDS-1CD155-20E	PDS-1CD175-20	PDS-1CD175-20E	PDS-1CD330-20
2.5	—	—	—	—	—	PDS-1CD330-25
3.0	PDS-1CD135-30	PDS-1CD155-30	PDS-1CD155-30E	PDS-1CD175-30	PDS-1CD175-30E	PDS-1CD330-30
3.5	—	—	—	—	—	PDS-1CD330-35
4.0	PDS-1CD135-40	PDS-1CD155-40	—	PDS-1CD175-40	—	—

Extended bur: Burs can be extended by 6 mm from the original length.

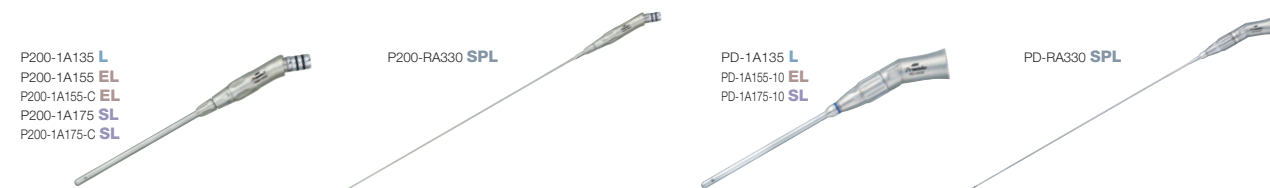

ROTARY INSTRUMENTS $\varnothing 1.0\text{ mm}$

Neuro Diamond Burs

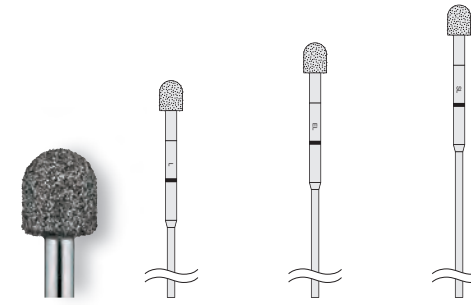

Head Size	Long	Extra Long	Super Long
	for P200-1A135 PD-1A135	for P200-1A155 P200-1A155-C PD-1A155-10	for P200-1A175 P200-1A175-C PD-1A175-10
2.0	PDS-1ND135-20	PDS-1ND155-20	PDS-1ND175-20
3.0	PDS-1ND135-30	PDS-1ND155-30	PDS-1ND175-30
4.0	PDS-1ND135-40	PDS-1ND155-40	PDS-1ND175-40

Neuro Coarse Diamond Burs

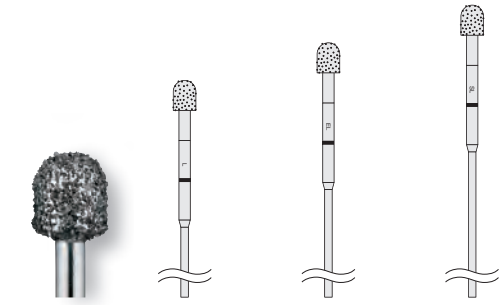

Head Size	Long	Extra Long	Super Long
	for P200-1A135 PD-1A135	for P200-1A155 P200-1A155-C PD-1A155-10	for P200-1A175 P200-1A175-C PD-1A175-10
2.0	PDS-1NCD135-20	PDS-1NCD155-20	PDS-1NCD175-20
3.0	PDS-1NCD135-30	PDS-1NCD155-30	PDS-1NCD175-30
4.0	PDS-1NCD135-40	PDS-1NCD155-40	PDS-1NCD175-40

Round Fluted Burs



Head Size	Extra Long	Super Long
	for P200-1A155 P200-1A155-C PD-1A155-10	for P200-1A175 P200-1A175-C PD-1A175-10
2.0	PDS-1C155-20	PDS-1C175-20
3.0	PDS-1C155-30	PDS-1C175-30
4.0	PDS-1C155-40	PDS-1C175-40

MH Cutting Burs



Head Size	Extra Long	Super Long
	for P200-1A155 P200-1A155-C PD-1A155-10	for P200-1A175 P200-1A175-C PD-1A175-10
2.5	PDS-1MHC155-25	PDS-1MHC175-25
3.0	PDS-1MHC155-30	PDS-1MHC175-30



ROTARY INSTRUMENTS $\varnothing 2.35$ mm

Round Fluted Burs

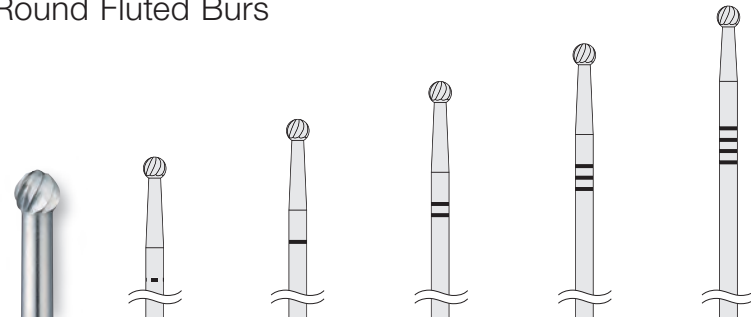

Head Size	MS	Extra Short	Short	Medium	Long
	for P200-2AMS P200-2SMS	for P200-2AES P200-2SES PD-2AES PD-2SES	for P200-2AS P200-2SS PD-2AS PD-2SS	for P200-2AM P200-2SM PD-2AM PD-2SM	for P200-2AL P200-2SL PD-2AL
1.0	PDS-2CMS-10	PDS-2CES-10	PDS-2CS-10	PDS-2CM-10	—
2.0	PDS-2CMS-20	PDS-2CES-20	PDS-2CS-20	PDS-2CM-20	PDS-2CL-20
3.0	PDS-2CMS-30	PDS-2CES-30	PDS-2CS-30	PDS-2CM-30	PDS-2CL-30
4.0	PDS-2CMS-40	PDS-2CES-40	PDS-2CS-40	PDS-2CM-40	PDS-2CL-40
5.0	PDS-2CMS-50	PDS-2CES-50	PDS-2CS-50	PDS-2CM-50	PDS-2CL-50
6.0	PDS-2CMS-60	PDS-2CES-60	PDS-2CS-60	PDS-2CM-60	PDS-2CL-60
7.0	PDS-2CMS-70	PDS-2CES-70	PDS-2CS-70	PDS-2CM-70	PDS-2CL-70

Carbide Burs

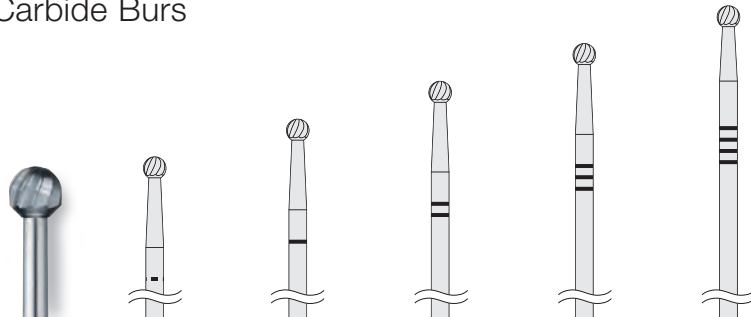

Head Size	MS	Extra Short	Short	Medium	Long
	for P200-2AMS P200-2SMS	for P200-2AES P200-2SES PD-2AES PD-2SES	for P200-2AS P200-2SS PD-2AS PD-2SS	for P200-2AM P200-2SM PD-2AM PD-2SM	for P200-2AL P200-2SL PD-2AL
2.0	PDS-2CBMS-20	PDS-2CBES-20	PDS-2CBS-20	PDS-2CBM-20	PDS-2CBL-20
3.0	PDS-2CBMS-30	PDS-2CBES-30	PDS-2CBS-30	PDS-2CBM-30	PDS-2CBL-30
4.0	PDS-2CBMS-40	PDS-2CBES-40	PDS-2CBS-40	PDS-2CBM-40	PDS-2CBL-40
5.0	PDS-2CBMS-50	PDS-2CBES-50	PDS-2CBS-50	PDS-2CBM-50	PDS-2CBL-50
6.0	PDS-2CBMS-60	PDS-2CBES-60	PDS-2CBS-60	PDS-2CBM-60	PDS-2CBL-60
7.0	PDS-2CBMS-70	PDS-2CBES-70	PDS-2CBS-70	PDS-2CBM-70	PDS-2CBL-70

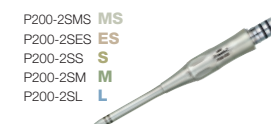
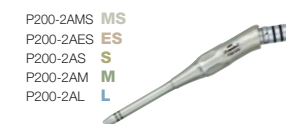
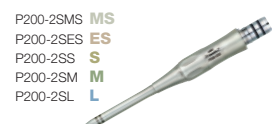
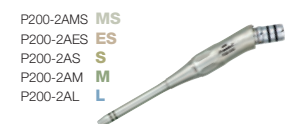

ROTARY INSTRUMENTS $\varnothing 2.35$ mm

Diamond Burs

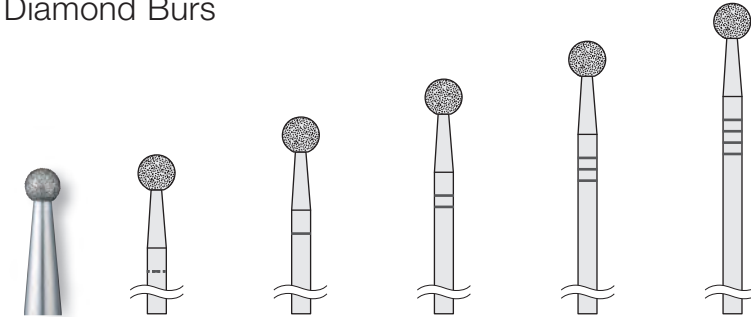

Head Size	MS	Extra Short	Short	Medium	Long
	for P200-2AMS P200-2SMS	for P200-2AES P200-2SES PD-2AES PD-2SES	for P200-2AS P200-2SS PD-2AS PD-2SS	for P200-2AM P200-2SM PD-2AM PD-2SM	for P200-2AL P200-2SL PD-2AL
0.6	PDS-2DMS-06	PDS-2DES-06	PDS-2DS-06	—	—
1.0	PDS-2DMS-10	PDS-2DES-10	PDS-2DS-10	PDS-2DM-10	—
1.5	PDS-2DMS-15	PDS-2DES-15	PDS-2DS-15	—	—
2.0	PDS-2DMS-20	PDS-2DES-20	PDS-2DS-20	PDS-2DM-20	PDS-2DL-20
3.0	PDS-2DMS-30	PDS-2DES-30	PDS-2DS-30	PDS-2DM-30	PDS-2DL-30
4.0	PDS-2DMS-40	PDS-2DES-40	PDS-2DS-40	PDS-2DM-40	PDS-2DL-40
5.0	PDS-2DMS-50	PDS-2DES-50	PDS-2DS-50	PDS-2DM-50	PDS-2DL-50
6.0	PDS-2DMS-60	PDS-2DES-60	PDS-2DS-60	PDS-2DM-60	PDS-2DL-60
7.0	PDS-2DMS-70	PDS-2DES-70	PDS-2DS-70	PDS-2DM-70	PDS-2DL-70

ROTARY INSTRUMENTS $\varnothing 2.35$ mm

Coarse Diamond Burs

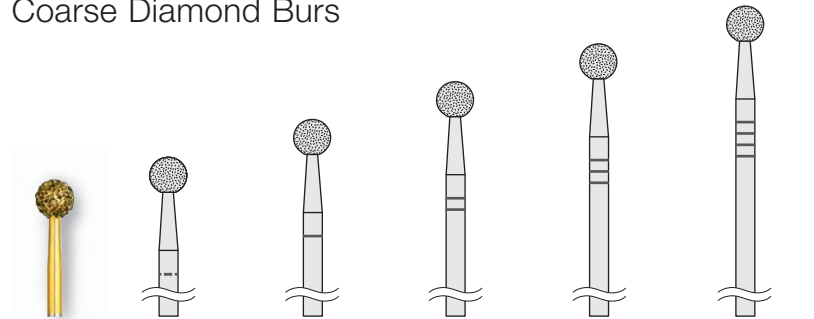

Head Size	MS	Extra Short	Short	Medium	Long
	for P200-2AMS P200-2SMS	for P200-2AES P200-2SES PD-2AES PD-2SES	for P200-2AS P200-2SS PD-2AS PD-2SS	for P200-2AM P200-2SM PD-2AM PD-2SM	for P200-2AL P200-2SL PD-2AL
1.0	PDS-2CDMS-10	PDS-2CDES-10	PDS-2CDS-10	—	—
1.5	PDS-2CDMS-15	PDS-2CDES-15	PDS-2CDS-15	—	—
2.0	PDS-2CDMS-20	PDS-2CDES-20	PDS-2CDS-20	PDS-2CDM-20	PDS-2CDL-20
3.0	PDS-2CDMS-30	PDS-2CDES-30	PDS-2CDS-30	PDS-2CDM-30	PDS-2CDL-30
4.0	PDS-2CDMS-40	PDS-2CDES-40	PDS-2CDS-40	PDS-2CDM-40	PDS-2CDL-40
5.0	PDS-2CDMS-50	PDS-2CDES-50	PDS-2CDS-50	PDS-2CDM-50	PDS-2CDL-50
6.0	PDS-2CDMS-60	PDS-2CDES-60	PDS-2CDS-60	PDS-2CDM-60	PDS-2CDL-60
7.0	PDS-2CDMS-70	PDS-2CDES-70	PDS-2CDS-70	PDS-2CDM-70	PDS-2CDL-70

Coarse Diamond Burs / Extended

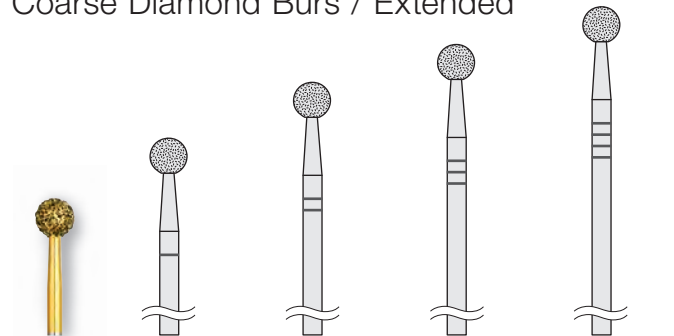

Head Size	Extra Short	Short [Extended]	Medium [Extended]	Long [Extended]
	for P200-2AES P200-2SES PD-2AES PD-2SES	for P200-2AS P200-2SS PD-2AS PD-2SS	for P200-2AM P200-2SM PD-2AM PD-2SM	for P200-2AL P200-2SL PD-2AL
1.0	PDS-2CDES-10E	—	—	—
1.5	PDS-2CDES-15E	—	—	—
2.0	—	PDS-2CDS-20E	PDS-2CDM-20E	PDS-2CDL-20E
3.0	—	PDS-2CDS-30E	PDS-2CDM-30E	PDS-2CDL-30E
4.0	—	PDS-2CDS-40E	PDS-2CDM-40E	PDS-2CDL-40E
5.0	—	PDS-2CDS-50E	PDS-2CDM-50E	PDS-2CDL-50E

Extended bur: Burs can be extended by 10 mm from the original length.



ROTARY INSTRUMENTS $\varnothing 2.35$ mm

Extra Coarse Diamond Burs

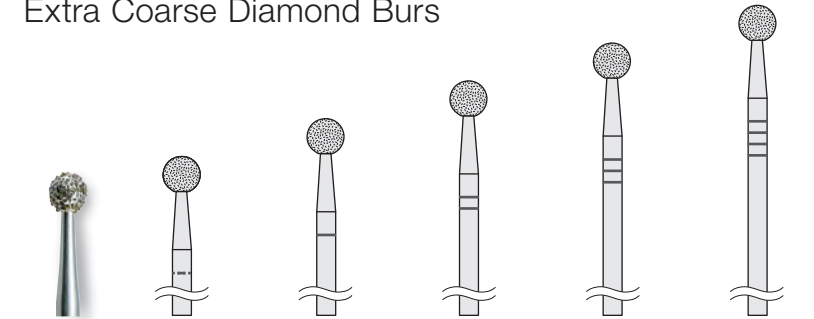

Head Size	MS	Extra Short	Short	Medium	Long
	for P200-2AMS P200-2SMS	for P200-2AES P200-2SES PD-2AES PD-2SES	for P200-2AS P200-2SS PD-2AS PD-2SS	for P200-2AM P200-2SM PD-2AM PD-2SM	for P200-2AL P200-2SL PD-2AL
3.0	PDS-2ECDMS-30	PDS-2ECDES-30	PDS-2ECDS-30	PDS-2ECDM-30	PDS-2ECDL-30
4.0	PDS-2ECDMS-40	PDS-2ECDES-40	PDS-2ECDS-40	PDS-2ECDM-40	PDS-2ECDL-40
5.0	PDS-2ECDMS-50	PDS-2ECDES-50	PDS-2ECDS-50	PDS-2ECDM-50	PDS-2ECDL-50
6.0	PDS-2ECDMS-60	PDS-2ECDES-60	PDS-2ECDS-60	PDS-2ECDM-60	PDS-2ECDL-60
7.0	PDS-2ECDMS-70	—	—	—	—

Super Coarse Diamond Burs

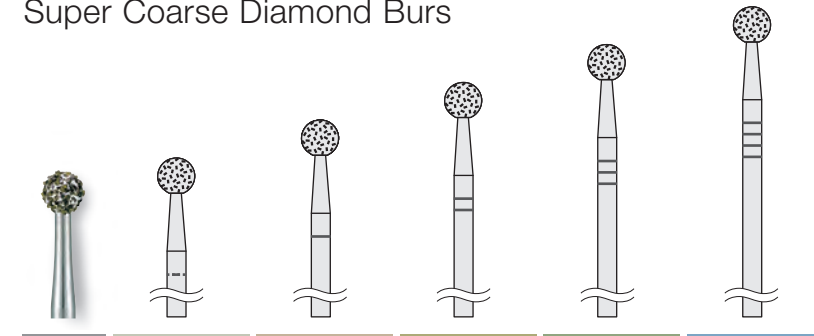

Head Size	MS	Extra Short	Short	Medium	Long
	for P200-2AMS P200-2SMS	for P200-2AES P200-2SES PD-2AES PD-2SES	for P200-2AS P200-2SS PD-2AS PD-2SS	for P200-2AM P200-2SM PD-2AM PD-2SM	for P200-2AL P200-2SL PD-2AL
3.0	PDS-2SCDMS-30	PDS-2SCDES-30	PDS-2SCDS-30	PDS-2SCDM-30	PDS-2SCDL-30
4.0	PDS-2SCDMS-40	PDS-2SCDES-40	PDS-2SCDS-40	PDS-2SCDM-40	PDS-2SCDL-40
5.0	PDS-2SCDMS-50	PDS-2SCDES-50	PDS-2SCDS-50	PDS-2SCDM-50	PDS-2SCDL-50
6.0	PDS-2SCDMS-60	PDS-2SCDES-60	PDS-2SCDS-60	PDS-2SCDM-60	PDS-2SCDL-60



ROTARY INSTRUMENTS $\varnothing 2.35$ mm

Neuro Burs

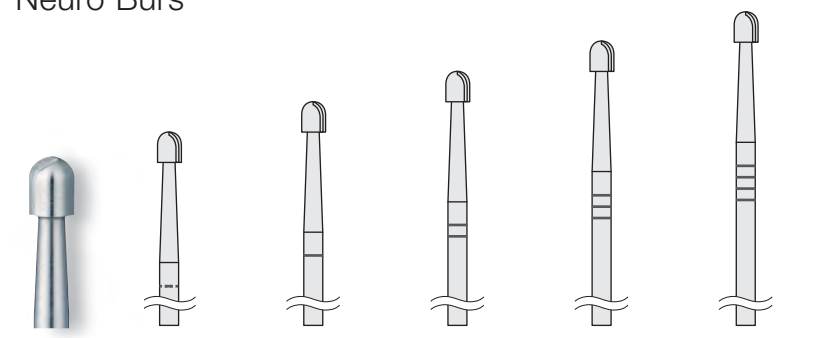

Head Size	MS	Extra Short	Short	Medium	Long
	for P200-2AMS P200-2SMS	for P200-2AES P200-2SES PD-2AES PD-2SES	for P200-2AS P200-2SS PD-2AS PD-2SS	for P200-2AM P200-2SM PD-2AM PD-2SM	for P200-2AL P200-2SL PD-2AL
1.8	PDS-2NMS-18	PDS-2NES-18	PDS-2NS-18	PDS-2NM-18	PDS-2NL-18
2.2	PDS-2NMS-22	PDS-2NES-22	PDS-2NS-22	PDS-2NM-22	PDS-2NL-22
3.0	PDS-2NMS-30	PDS-2NES-30	PDS-2NS-30	PDS-2NM-30	PDS-2NL-30

Neuro Carbide Burs

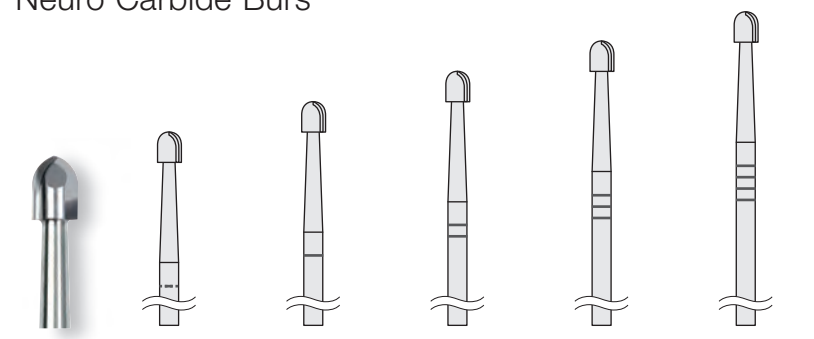

Head Size	MS	Extra Short	Short	Medium	Long
	for P200-2AMS P200-2SMS	for P200-2AES P200-2SES PD-2AES PD-2SES	for P200-2AS P200-2SS PD-2AS PD-2SS	for P200-2AM P200-2SM PD-2AM PD-2SM	for P200-2AL P200-2SL PD-2AL
1.8	PDS-2NCBMS-18	PDS-2NCBES-18	PDS-2NCBS-18	PDS-2NCBM-18	PDS-2NCBL-18
2.2	PDS-2NCBMS-22	PDS-2NCBES-22	PDS-2NCBS-22	PDS-2NCBM-22	PDS-2NCBL-22
3.0	PDS-2NCBMS-30	PDS-2NCBES-30	PDS-2NCBS-30	PDS-2NCBM-30	PDS-2NCBL-30

P200-2AMS **MS**
P200-2AES **ES**
P200-2AS **S**
P200-2AM **M**
P200-2AL **L**

P200-2SMS **MS**
P200-2SES **ES**
P200-2SS **S**
P200-2SM **M**
P200-2SL **L**

PD-2AES **ES**
PD-2AS **S**
PD-2AM **M**
PD-2AL **L**

PD-2SES **ES**
PD-2SS **S**
PD-2SM **M**

ROTARY INSTRUMENTS $\varnothing 2.35$ mm

Egg Burs

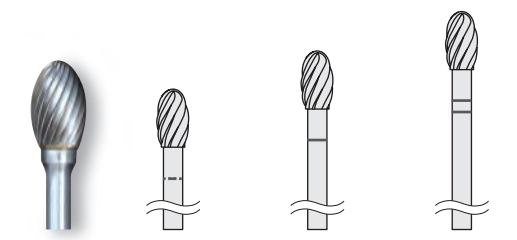

Head Size	MS	Extra Short	Short
	for P200-2AMS P200-2SMS	for P200-2AES P200-2SES PD-2AES PD-2SES	for P200-2AS P200-2SS PD-2AS PD-2SS
4.0	PDS-2EMS-40	PDS-2EES-40	PDS-2ES-40
6.0	PDS-2EMS-60	PDS-2EES-60	PDS-2ES-60

Barrel Burs



Head Size	MS	Extra Short	Short
	for P200-2AMS P200-2SMS	for P200-2AES P200-2SES PD-2AES PD-2SES	for P200-2AS P200-2SS PD-2AS PD-2SS
4.0	PDS-2BMS-40	PDS-2BES-40	PDS-2BS-40
6.0	PDS-2BMS-60	PDS-2BES-60	PDS-2BS-60

Pear Burs

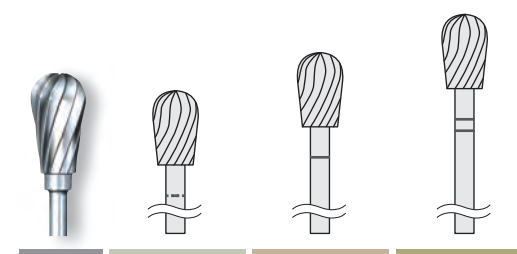

Head Size	MS	Extra Short	Short
	for P200-2AMS P200-2SMS	for P200-2AES P200-2SES PD-2AES PD-2SES	for P200-2AS P200-2SS PD-2AS PD-2SS
6.0	PDS-2PMS-60	PDS-2PES-60	PDS-2PS-60

P200-2AMS **MS**
P200-2AES **ES**
P200-2AS **S**

P200-2SMS **MS**
P200-2SES **ES**
P200-2SS **S**

PD-2AES **ES**
PD-2AS **S**

PD-2SES **ES**
PD-2SS **S**

ROTARY INSTRUMENTS $\varnothing 2.35$ mm

Lindemann Burs

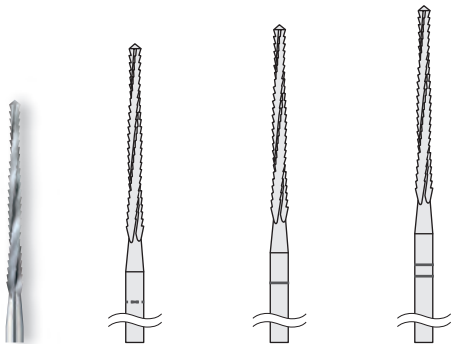

Length, Head Size	MS	Extra Short	Short
	for P200-2AMS P200-2SMS	for P200-2AES P200-2SES PD-2AES PD-2SES	for P200-2AS P200-2SS PD-2AS PD-2SS
11 x 2.1	PDS-2LMS-11	PDS-2LES-11	PDS-2LS-11
26 x 2.3	PDS-2LMS-26	PDS-2LES-26	PDS-2LS-26

Fissure Burs

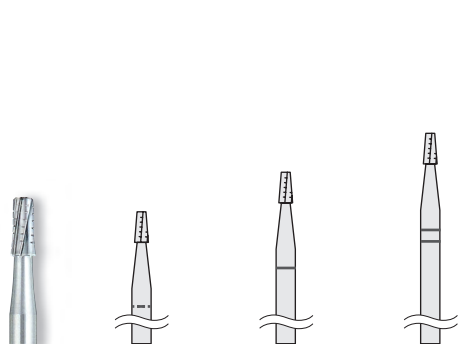

Head Size	MS	Extra Short	Short
	for P200-2AMS P200-2SMS	for P200-2AES P200-2SES PD-2AES PD-2SES	for P200-2AS P200-2SS PD-2AS PD-2SS
1.2	PDS-2FMS-12	PDS-2FES-12	PDS-2FS-12
1.6	PDS-2FMS-16	PDS-2FES-16	PDS-2FS-16
2.1	PDS-2FMS-21	PDS-2FES-21	PDS-2FS-21

Acorn Burs

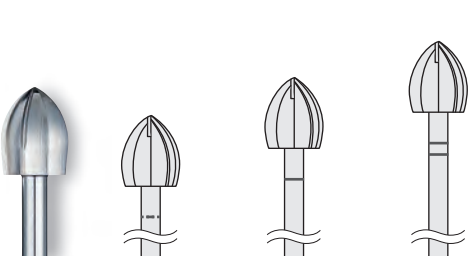

Head Size	MS	Extra Short	Short
	for P200-2AMS P200-2SMS	for P200-2AES P200-2SES PD-2AES PD-2SES	for P200-2AS P200-2SS PD-2AS PD-2SS
5.0	PDS-2AMS-50	PDS-2AES-50	PDS-2AS-50
6.0	PDS-2AMS-60	PDS-2AES-60	PDS-2AS-60
7.5	PDS-2AMS-75	PDS-2AES-75	PDS-2AS-75

Router Burs

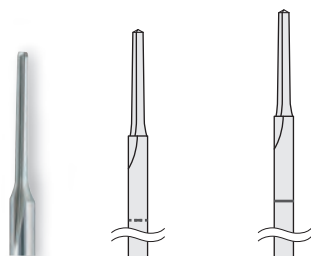

Head Size	MS	Extra Short
	for P200-2AMS P200-2SMS	for P200-2AES P200-2SES PD-2AES PD-2SES
1.3	PDS-2RMS-13	PDS-2RES-13

P200-2AMS **MS**
P200-2AES **ES**
P200-2AS **S**

P200-2SMS **MS**
P200-2SES **ES**
P200-2SS **S**

PD-2AES **ES**
PD-2AS **S**

PD-2SES **ES**
PD-2SS **S**

ROTARY INSTRUMENTS $\varnothing 3.17$ mm

Wirepass Drills

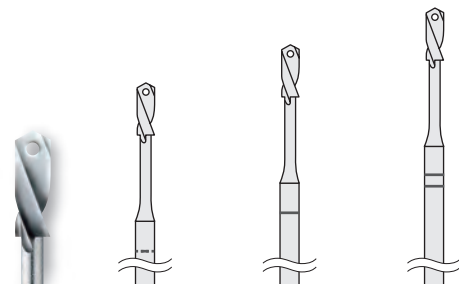

Head Size	MS	Extra Short	Short
	for P200-2AMS P200-2SMS	for P200-2AES P200-2SES PD-2AES PD-2SES	for P200-2AS P200-2SS PD-2AS PD-2SS
1.0	PDS-2WMS-10	PDS-2WES-10	PDS-2WS-10
1.2	PDS-2WMS-12	PDS-2WES-12	PDS-2WS-12
1.5	PDS-2WMS-15	PDS-2WES-15	PDS-2WS-15

P200-2AMS **MS**
P200-2AES **ES**
P200-2AS **S**

P200-2SMS **MS**
P200-2SES **ES**
P200-2SS **S**

PD-2AES **ES**
PD-2AS **S**

PD-2SES **ES**
PD-2SS **S**

Twist Drill Flat Tail

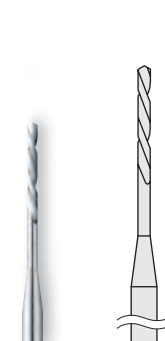

Head Size	MS
	for P200-2SD PD-2SD PD-2AD
1.0	PDS-2TD-10
1.5	PDS-2TD-15
2.0	PDS-2TD-20

P200-2SD

PD-2SD

PD-2AD

ROTARY INSTRUMENTS $\varnothing 3.17$ mm

Craniotome Handpiece Burs

Pediatric	Medium	Long
for P200-CRD-P PD-CRD-P	for P200-CRD-M PD-CRD-M	for P200-CRD-L PD-CRD-L
PDS-CRA-P	PDS-CRA-M	PDS-CRA-L

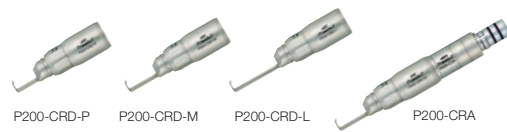

Router Burs

Pediatric	Medium	Long
for P200-CRD-P PD-CRD-P	for P200-CRD-M PD-CRD-M	for P200-CRD-L PD-CRD-L
PDS-ROU-P	PDS-ROU-M	PDS-ROU-L



Round Fluted Burs

Head Size	Short	Medium	Long
	for P200-3GAS	for P200-3GAM	for P200-3GAL
1.0	PDS-3CS-10	PDS-3CM-10	—
2.0	PDS-3CS-20	PDS-3CM-20	PDS-3CL-20
3.0	PDS-3CS-30	PDS-3CM-30	PDS-3CL-30
4.0	PDS-3CS-40	PDS-3CM-40	PDS-3CL-40
5.0	PDS-3CS-50	PDS-3CM-50	PDS-3CL-50
6.0	PDS-3CS-60	PDS-3CM-60	PDS-3CL-60
7.0	PDS-3CS-70	PDS-3CM-70	PDS-3CL-70



ROTARY INSTRUMENTS $\varnothing 3.17$ mm

Diamond Burs

Head Size	Short	Medium	Medium [Extended]	Long	Long [Extended]
	for P200-3GAS	for P200-3GAM	for P200-3GAM	for P200-3GAL	for P200-3GAL
1.0	PDS-3DS-10	PDS-3DM-10	—	—	—
2.0	PDS-3DS-20	PDS-3DM-20	PDS-3DM-20E	PDS-3DL-20	PDS-3DL-20E
3.0	PDS-3DS-30	PDS-3DM-30	—	PDS-3DL-30	—
4.0	PDS-3DS-40	PDS-3DM-40	—	PDS-3DL-40	—
5.0	PDS-3DS-50	PDS-3DM-50	—	PDS-3DL-50	—
6.0	PDS-3DS-60	PDS-3DM-60	—	PDS-3DL-60	—
7.0	PDS-3DS-70	PDS-3DM-70	—	PDS-3DL-70	—

Extended bur: Burs can be extended by 10 mm from the original length.

Coarse Diamond Burs

Head Size	Short	Medium	Medium [Extended]	Long	Long [Extended]
	for P200-3GAS	for P200-3GAM	for P200-3GAM	for P200-3GAL	for P200-3GAL
2.0	PDS-3CDS-20	PDS-3CDM-20	—	PDS-3CDL-20	—
3.0	PDS-3CDS-30	PDS-3CDM-30	PDS-3CDM-30E	PDS-3CDL-30	PDS-3CDL-30E
4.0	PDS-3CDS-40	PDS-3CDM-40	PDS-3CDM-40E	PDS-3CDL-40	PDS-3CDL-40E
5.0	PDS-3CDS-50	PDS-3CDM-50	PDS-3CDM-50E	PDS-3CDL-50	PDS-3CDL-50E
6.0	PDS-3CDS-60	PDS-3CDM-60	—	PDS-3CDL-60	—
7.0	PDS-3CDS-70	PDS-3CDM-70	—	PDS-3CDL-70	—

Extended bur: Burs can be extended by 10 mm from the original length.



ROTARY INSTRUMENTS $\varnothing 3.17$ mm

Neuro Burs

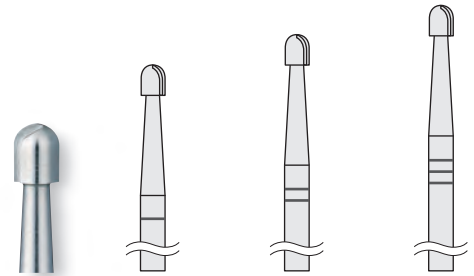

Head Size	Short	Medium	Long
	for P200-3GAS	for P200-3GAM	for P200-3GAL
1.8	PDS-3NS-18	PDS-3NM-18	PDS-3NL-18
2.2	PDS-3NS-22	PDS-3NM-22	PDS-3NL-22
3.0	PDS-3NS-30	PDS-3NM-30	PDS-3NL-30



ROTARY INSTRUMENTS $\varnothing 3.17$ mm

Acorn Burs

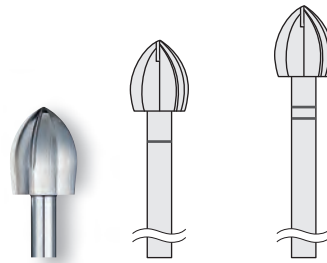

Head Size	Short	Medium
	for P200-3GAS	for P200-3GAM
7.5	PDS-3AS-75	PDS-3AM-75
9.0	PDS-3AS-90	PDS-3AM-90



Cylinder Burs

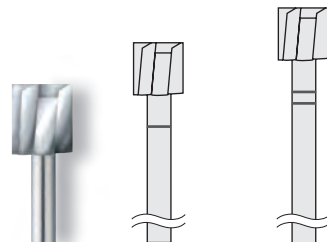

Head Size	Short	Medium
	for P200-3GAS	for P200-3GAM
6.0	PDS-3BS-60	PDS-3BM-60
9.1	PDS-3BS-91	PDS-3BM-91

Metal Cutting Carbide Bur



Head Size	for P200-3MC
1.6	PDS-3MCS-CB16
3.0	PDS-3MCS-CB30



Metal Cutting Diamond Disc

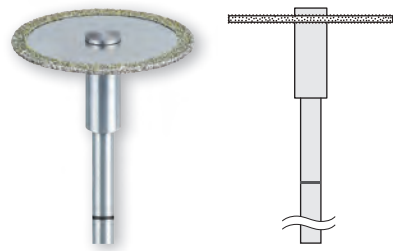

Head Size	for P200-3MC
25.4	PDS-3MCS-DD254

SAW BLADES

Sagittal and Oscillating Saw Blades Scale : 1/1

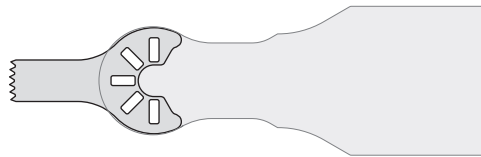

order code
PDS-SO-411
• Thickness : 0.4 mm

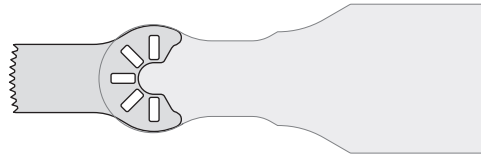

order code
PDS-SO-412
• Thickness : 0.4 mm

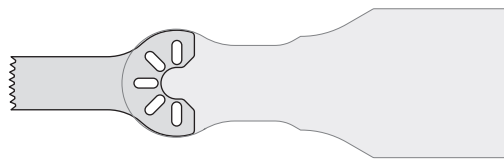

order code
PDS-SO-422
• Thickness : 0.4 mm

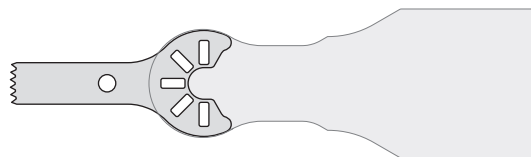

order code
PDS-SO-431
• Thickness : 0.4 mm

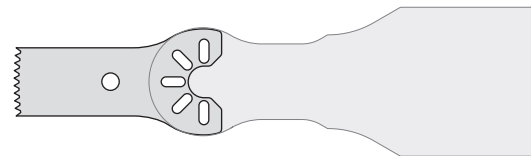

order code
PDS-SO-432
• Thickness : 0.4 mm

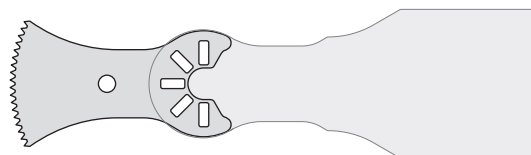

order code
PDS-SO-433
• Thickness : 0.4 mm

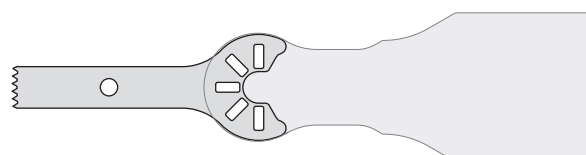

order code
PDS-SO-441
• Thickness : 0.4 mm



P200-SAG



P200-OSC



PD-SA-S

SAW BLADES

Sagittal and Oscillating Saw Blades Scale : 1/1

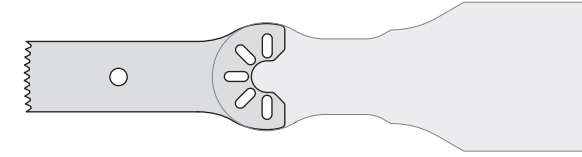

order code
PDS-SO-442
• Thickness : 0.4 mm

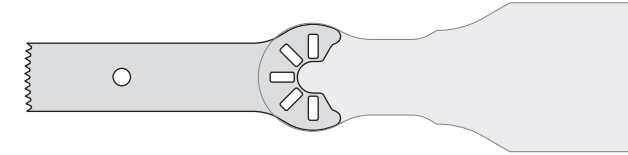

order code
PDS-SO-452
• Thickness : 0.4 mm

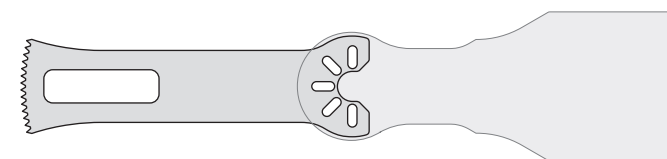

order code
PDS-SO-453
• Thickness : 0.4 mm

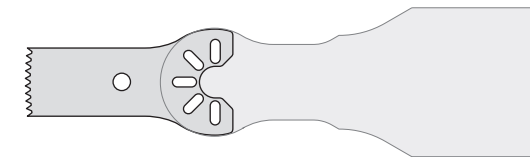

order code
PDS-SO-632
• Thickness : 0.6 mm

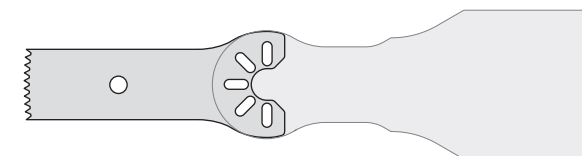

order code
PDS-SO-642
• Thickness : 0.6 mm

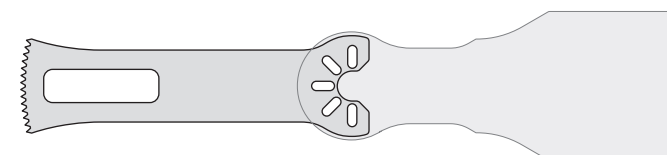

order code
PDS-SO-653
• Thickness : 0.6 mm



P200-SAG



P200-OSC



PD-SA-S

INTRA ORAL BLADES

Oscillating Saw Blades (for Intra Oral) Scale : 1/1

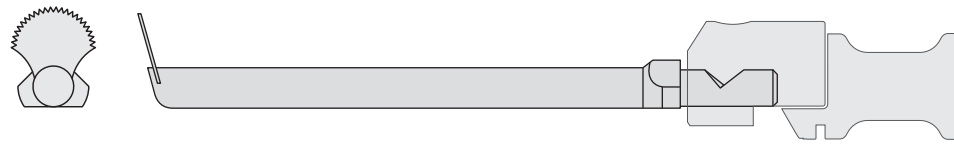

order code
PDS-OSC-422
• Thickness : 0.4 mm

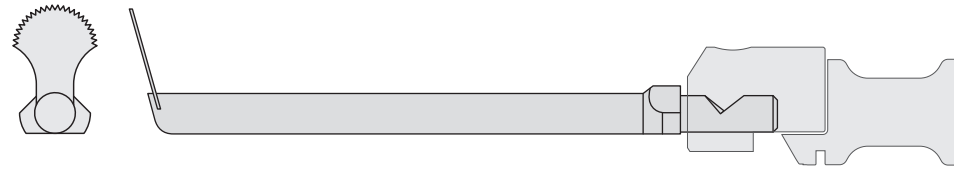

order code
PDS-OSC-432
• Thickness : 0.4 mm



order code
PD-OSC-A
Adaptor
• For Oscillating Intra Oral Blades
• Bundled Item: Corresponding wrench (1), and screws (2)

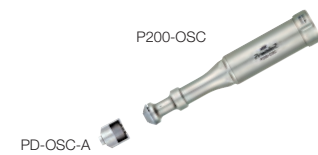

P200-OSC

PD-OSC-A

SAW BLADES

Reciprocating Saw Blades Scale : 1/1

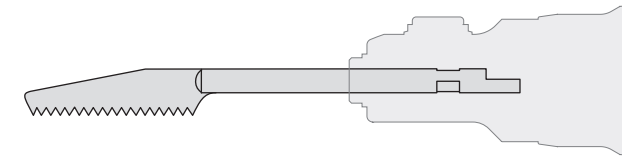

order code
PDS-RE-4023
• Thickness : 0.4 mm

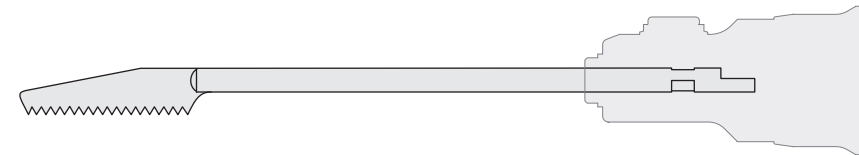

order code
PDS-RE-4023E
• Thickness : 0.4 mm

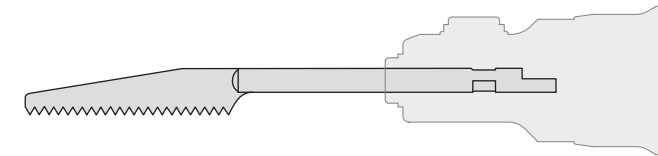

order code
PDS-RE-4028
• Thickness : 0.4 mm

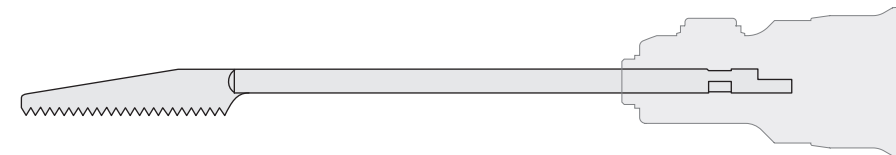

order code
PDS-RE-4028E
• Thickness : 0.4 mm



P200-REC



PD-SA-R

SAW BLADES

Reciprocating Saw Blades Scale : 1/1

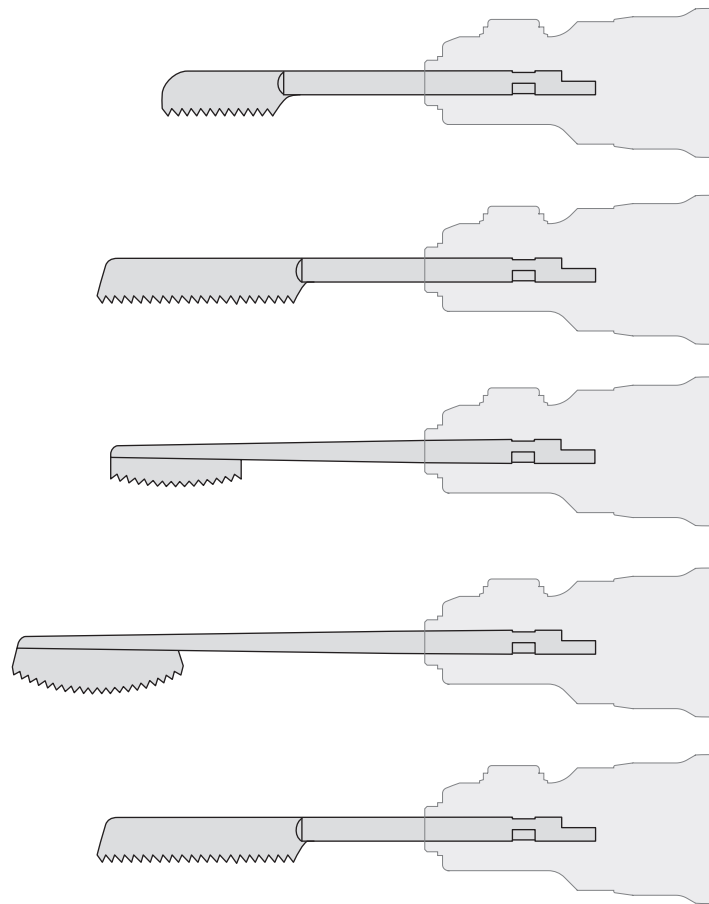

order code
PDS-RE-4114
• Thickness : 0.4 mm

order code
PDS-RE-4127
• Thickness : 0.4 mm

order code
PDS-RE-4217
• Thickness : 0.4 mm

order code
PDS-RE-4223
• Thickness : 0.4 mm

order code
PDS-RE-6127
• Thickness : 0.6 mm



RASPS

Reciprocating Rasps Scale : 1/1

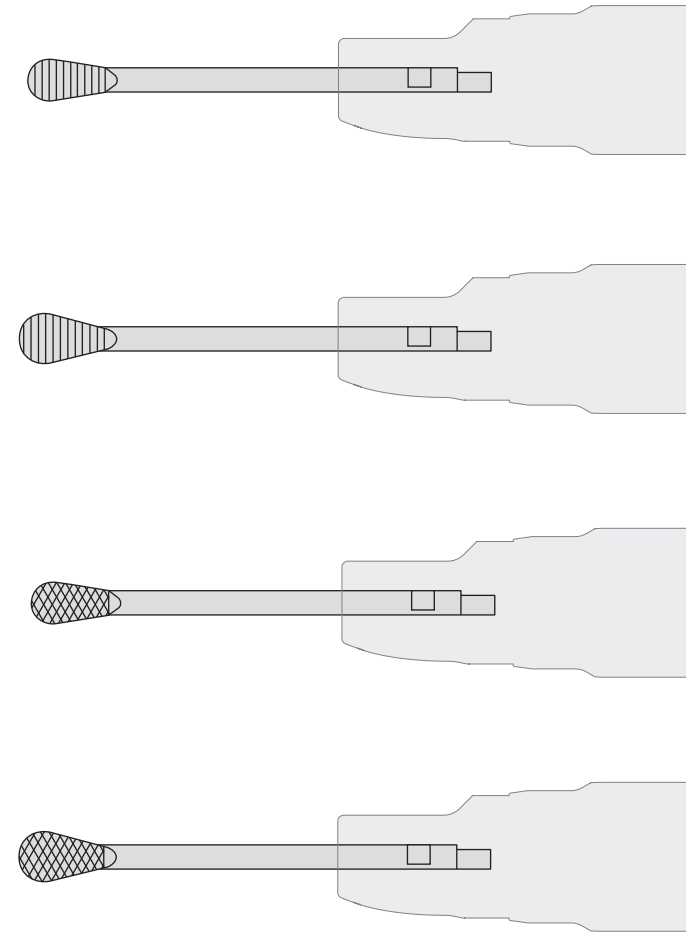

order code
PDS-RE-R011
• Straight

order code
PDS-RE-R012
• Straight

order code
PDS-RE-R111
• Cross-Cut

order code
PDS-RE-R112
• Cross-Cut



MEMO

Manufacturer

NAKANISHI INC. www.nsk-surgery.com

700 Shimohinata, Kanuma, Tochigi 322-8666, Japan
TEL : +81 (0)289-64-3380 FAX : +81 (0)289-64-3890

NSK America Corp

1800 Global Parkway, Hoffman Estates, IL 60192, USA
TEL : +1 888 675 1675 FAX : +1 800 838 9328

Specifications are subject to change without notice. Burs / Blades / Rasps are sterilized. Burs / Blades / Rasps are "Single Use" only.