

SLIM MOTOR SERIES

- Primado2 Slim Motor
- Slim Handpiece 200
- Super Slim Handpiece 200
- Standard Angled Handpiece 200
- Standard Straight Handpiece 200
- Perforator / Drill Handpiece 200
- Craniotome / Metal Cutting

MICRO BONE SAW SERIES

- Reciprocating Saw Handpiece
- Sagittal Saw Handpiece
- Oscillating Saw Handpiece

FOOT CONTROL

- Primado2 Foot Control

WIRE PIN DRIVER SERIES

- Primado2 Wire Pin Driver
- Wire & Pin Collet
- Drill Attachment
- Reamer Attachment
- Saw Attachment

HIGH TORQUE MOTOR SERIES

- Primado2 High Torque Motor
- High Speed Handpiece 200
- Slim Handpiece
- Super Slim Handpiece
- Standard Angled Handpiece
- Standard Straight Handpiece
- Perforator / Craniotome Handpiece
- Drill / Contra Angle Handpiece



CREATE IT.

www.nsk-surgery.com



REF PR-M0049E v1 17.05.04

Feel the difference

Made in Japan, Primado2 is NSK's second generation high-speed total surgical system developed to meet strict demands from surgeons.

Since the launch of the first generation of Primado in 2006, we have been working with surgeons across the world. Their needs and requests gave shape to the new Primado2 which we created with balance, power, and a lightweight design to prevent stress from long operating hours.

We invite you to experience Primado2 – the next evolution of high speed drills.



Primado2

Total Surgical System

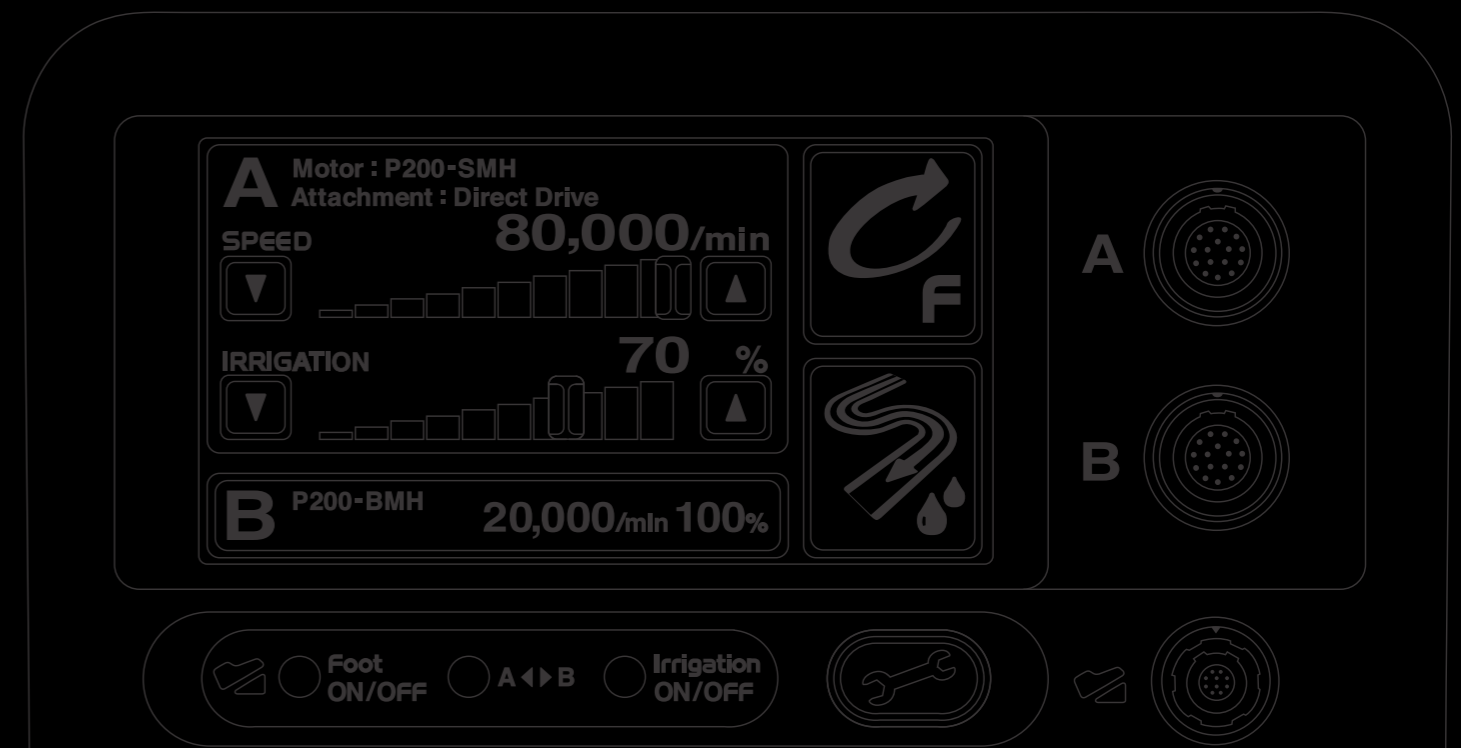

Primado2 Product Lineup

Slim Motor Series

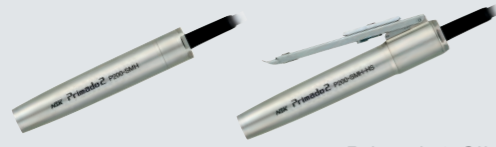

Primado2 Slim Motor **12**



Slim Handpiece 200 **13**

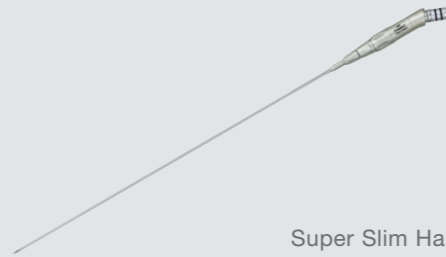

Super Slim Handpiece 200 **14**



Standard Angled Handpiece 200 **15**



Standard Straight Handpiece 200 **16**



Perforator / Drill Handpiece 200 **17**



Craniotome / Metal Cutting **18**

Micro Bone Saw Series

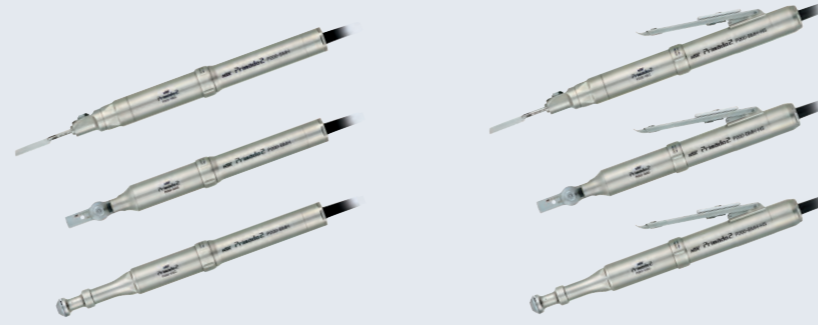

Primado2 Micro Bone Saw **32**

Primado2 Total Surgical System



Primado2 Control Unit **08**

Foot Control

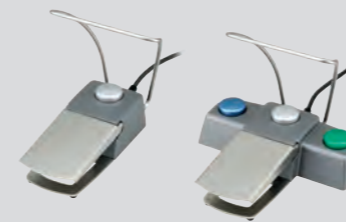

Primado2 Foot Control **10**

Wire Pin Driver Series



Primado2 Wire Pin Driver **36**

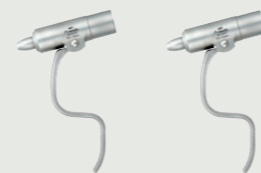

Wire & Pin Collet **37**



Drill Attachment **37**



Reamer Attachment **38**



Saw Attachment **38**

High Torque Motor Series



Primado2 High Torque Motor **20**



High Speed Handpiece 200 **21**



Slim Handpiece **23**



Super Slim Handpiece **24**



Standard Angled Handpiece **25**



Standard Straight Handpiece **26**

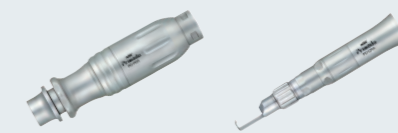

Perforator / Craniotome Handpiece **27**



Drill / Contra Angle Handpiece **29**

FEEL THE DIFFERENCE

Made in Japan, Primado2 is NSK's second generation high-speed total surgical system developed to meet strict demands from surgeons.

Since the launch of the first generation of Primado in 2006, we have been working with surgeons across the world. Their needs and requests gave shape to the new Primado2 which we created with balance, power, and a lightweight design to prevent stress from long operating hours.

We invite you to experience Primado2 – the next evolution of high speed drills.



THE SIGN OF EXCELLENCE

Primado2 makes it possible to conduct various types of procedures. New features include a control unit with LCD display touch screen, a multifunctional foot control, four lineups of motor and extensive attachments. Since all Primado2 motors and handpieces are thermo disinfectant compatible, easy maintenance is achievable.





Primado2 Control Unit

The control unit has a new 6.5 inch LCD screen and a simple design that makes it user friendly.

Two motors can be connected to the unit simultaneously, allowing for quick and easy switching between motors.

order code

P200-CU-120

Primado2 Control Unit for 120V

order code

P200-CU-230

Primado2 Control Unit for 230V

- Power Supply : AC120V / 230V 50/60 Hz
- Dimension : W278 x D268 x H160 (mm)
- Weight : 6.9 kg

Settings

Extensive options are available

Control Unit

- Brightness • Volume
- Language (English, Japanese, German, French, Spanish, Italian)

Motor Handpiece

- Accelerator adjustment (min. 10% - max. 100%)
- Brake adjustment (min. 10% - max. 100%)
- Torque adjustment (min. 30% - 100%)
- Oscillation adjustment (1 - 5 times, available only for Wire Pin Driver)

Attachment

- Handpiece selection (Displays rotation speed of engaged handpiece)

Touch Panel

Main Panel

- Speed control
- Irrigation control
- Reverse rotation control
- Priming control

Sub Panel

- Displays the assigned function of each.

Mini Panel

- Button for optional settings.

Configuration Settings

The control unit saves the configurations made by the last user except for speed, allowing the surgeons to proceed quickly.

Automatic Recognition for Motors

Four types of motor are automatically recognized by the control unit which displays the corresponding models and rotation speed for each.

Integrated High Performance Irrigation Pump

Primado2 comes equipped with an irrigation pump. Irrigation is adjusted up to a max of 75ml/min.



Primado2 Foot Control

The foot control is available in two models: single (one functional button), and multi (three functional buttons). Each button can be set to a specific function to meet the operator's preference.



Functional Options

<Allocatable Features>

- Foot control ON/OFF
- A ⇄ B control (switching between motors)
- Speed control
(adjust rotational speed; min. 30% ⇒ default ⇒ max. 100%)
- Reverse rotation mode
- Irrigation ON/OFF
- Flush (continuous 100% irrigation when pressed)
- Disable (Set the status as no function)



order code
FC-73

Primado2 Single Foot Control

- 1 pedal with 1 functional button
- Speed control : variable
- IP rating : IPX8



order code
FC-74

Primado2 Multi Foot Control

- 1 pedal with 3 functional buttons
- Speed control : variable
- IP rating : IPX8

Slim Motor Series

- Slim Design** : A new compact and lightweight design reduces surgeon fatigue during long operations.
- High Speed** : High speed rotation with a maximum of 80,000min⁻¹ ensures precise cutting.
- Versatile** : Foot control and hand control options available.
- Easy Maintenance** : All motors and handpieces can be processed by a thermo disinfectant.
- Durable** : The Slim Motor Series features a durable design as a result of NSK's long history with high precision technology. The wear-resistant coating contributes to long-lasting and scratch-free products of the high quality.



Primado2 Slim Motor



order code
P200-SMH-HS

Primado2 Slim Motor/HS

- Hand Control type
- Speed: Max. 80,000 min⁻¹
- Available handpieces: 20 types
- Bundled Item: P200-EZ-SM (see p.40)

order code
P200-SMH

Primado2 Slim Motor

- Speed: Max. 80,000 min⁻¹
- Available handpieces: 20 types
- Bundled Item: P200-EZ-SM (see p.40)

Slim Handpiece 200 for $\varnothing 1.0$ mm bur 80,000 min⁻¹

The Slim Handpiece 200 has a 4.8mm diameter bur guard. Various length in curved and straight models that deliver great visualization in endoscopic and minimally invasive spine procedures. The bur guard can be removed with a wrench that is included to provide easy maintenance.



Irrigation Nozzle

order code
P200-IN-1A155
For P200-1A155 (EL)
For P200-1A155-C (EL/Curved)

order code
P200-IN-1A175
For P200-1A175 (SL)
For P200-1A175-C (SL/Curved)



order code

P200-1ARA-W

Wrench for Slim/Super Slim

- Corresponding wrench for bur guard
- Included with Slim Handpiece 200

order code

P200-1A135

Slim Handpiece200 L

- Long type
- Bur: $\varnothing 1.0$ mm / Long

order code

P200-1A155

Slim Handpiece200 EL

- Extra Long type
- Bur: $\varnothing 1.0$ mm / Extra Long

order code

P200-1A175

Slim Handpiece200 SL

- Super Long type
- Bur: $\varnothing 1.0$ mm / Super Long

order code

P200-1A155-C

Slim Handpiece200 EL/Curved

- Extra Long, Curving type
- Bur: $\varnothing 1.0$ mm / Extra Long

order code

P200-1A175-C

Slim Handpiece200 SL/Curved

- Super Long, Curving type
- Bur: $\varnothing 1.0$ mm / Super Long

Super Slim Handpiece 200 for $\varnothing 1.0$ mm bur 20,000 min⁻¹

The Super Slim Handpiece 200 has a 2.1mm diameter bur guard. It is exclusively designed to perform the endoscopic procedure with precise and sensitive drilling of 20,000min⁻¹ at maximum in rotation speed. The bur guard can be removed with a wrench that is included to provide easy maintenance.

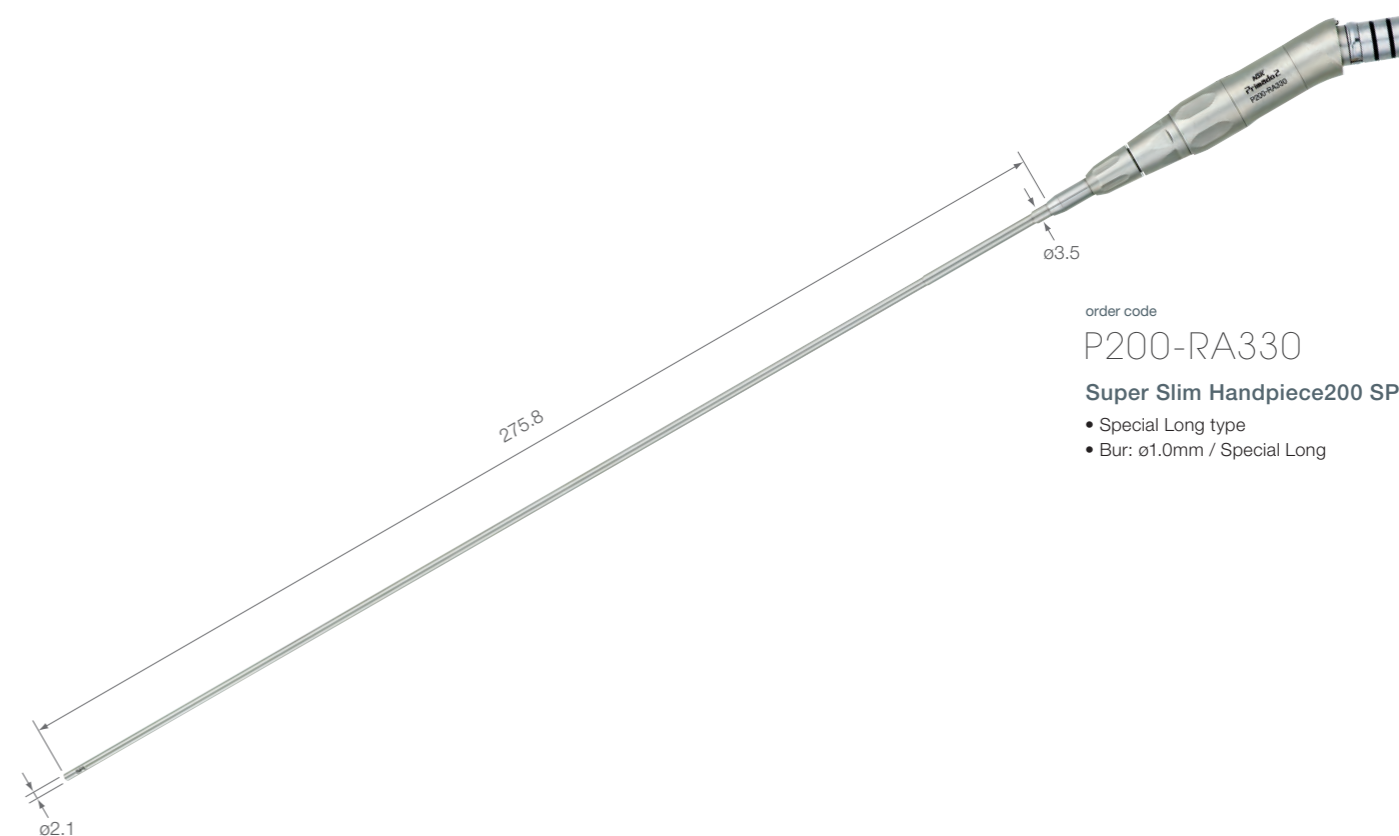

order code

P200-RA330

Super Slim Handpiece200 SPL

- Special Long type
- Bur: $\varnothing 1.0$ mm / Special Long

order code

P200-1ARA-W

Wrench for Slim/Super Slim

- Corresponding wrench for bur guard
- Included with Super Slim Handpiece 200



Standard Angled Handpiece 200 for $\varnothing 2.35$ mm bur 80,000 min⁻¹

Five different lengths of handpieces are available with the Standard Angled Handpiece 200 to address various types of procedures. Consistent rotation and well-balanced ergonomic design relieves fatigue.

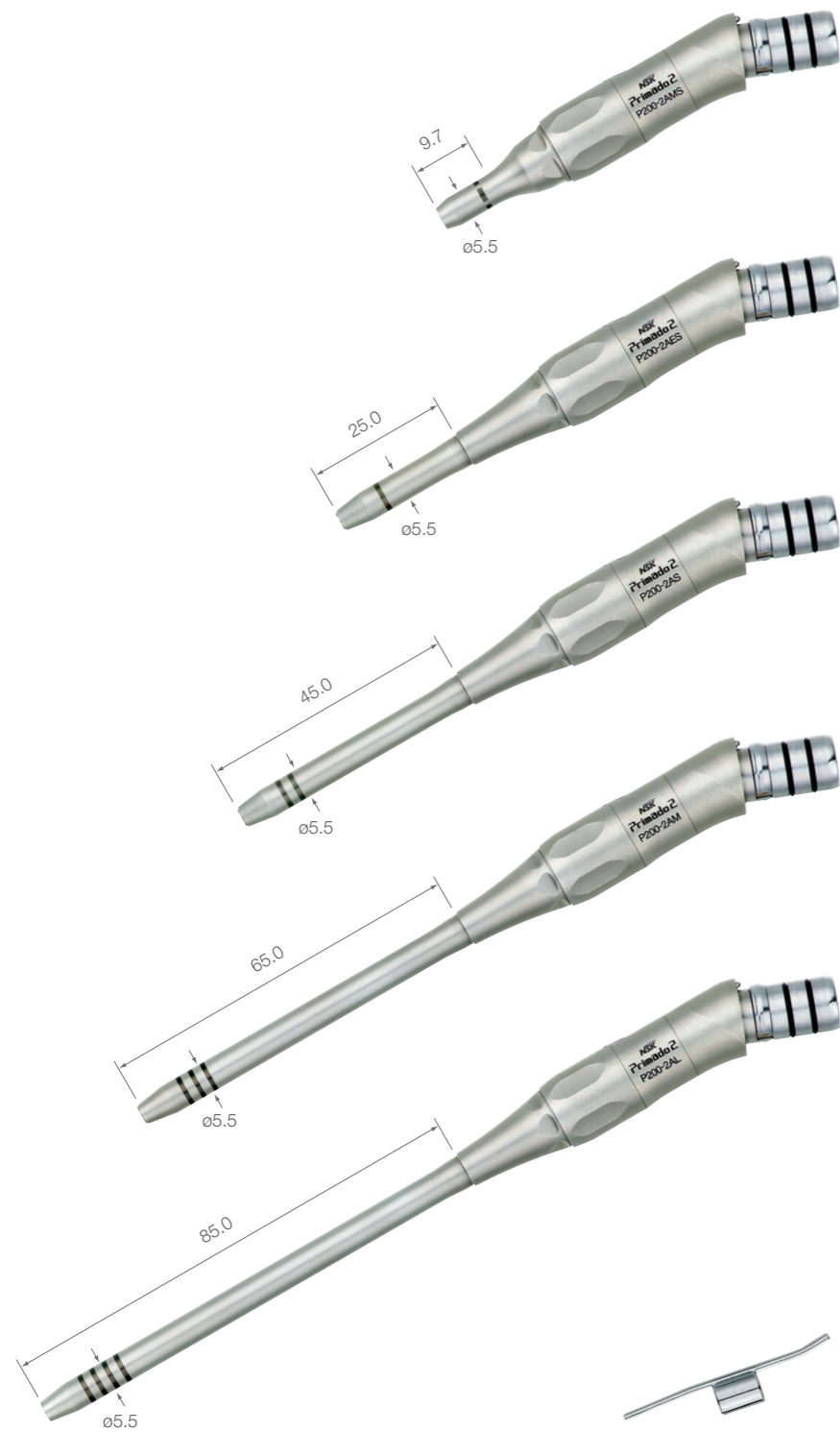

order code

P200-2AMS

Std. Angled Handpiece200 MS

- Mini type
- Bur: $\varnothing 2.35$ mm / MS

order code

P200-2AES

Std. Angled Handpiece200 ES

- Extra Short type
- Bur: $\varnothing 2.35$ mm / Extra Short

order code

P200-2AS

Std. Angled Handpiece200 S

- Short type
- Bur: $\varnothing 2.35$ mm / Short

order code

P200-2AM

Std. Angled Handpiece200 M

- Medium type
- Bur: $\varnothing 2.35$ mm / Medium

order code

P200-2AL

Std. Angled Handpiece200 L

- Long type
- Bur: $\varnothing 2.35$ mm / Long

Irrigation Nozzle

order code

PD-IN-D

For P200-2AMS (MS)

order code

PD-IN-2ES

For P200-2AES (ES)

order code

PD-IN-2S

For P200-2AS (S)

order code

PD-IN-2M

For P200-2AM (M)

order code

PD-IN-2L

For P200-2AL (L)

Standard Straight Handpiece 200 for $\varnothing 2.35$ mm bur 80,000 min⁻¹

Five different lengths of handpieces are available with the Standard Straight Handpiece 200 to address various types of procedures. Consistent rotation and well-balanced ergonomic design relieves fatigue.

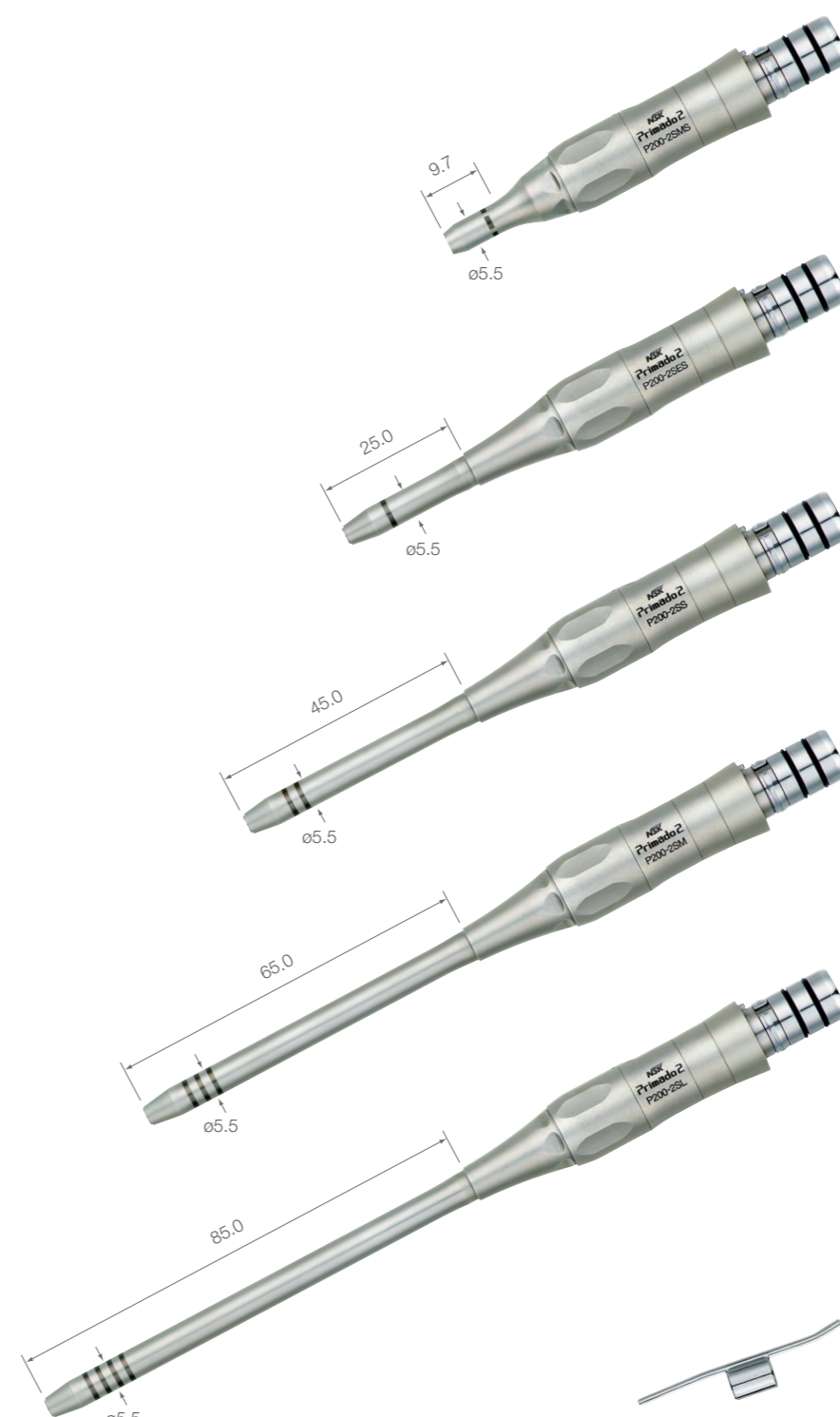

order code

P200-2SMS

Std. Straight Handpiece200 MS

- Mini type
- Bur: $\varnothing 2.35$ mm / MS

order code

P200-2SES

Std. Straight Handpiece200 ES

- Extra Short type
- Bur: $\varnothing 2.35$ mm / Extra Short

order code

P200-2SS

Std. Straight Handpiece200 S

- Short type
- Bur: $\varnothing 2.35$ mm / Short

order code

P200-2SM

Std. Straight Handpiece200 M

- Medium type
- Bur: $\varnothing 2.35$ mm / Medium

order code

P200-2SL

Std. Straight Handpiece200 L

- Long type
- Bur: $\varnothing 2.35$ mm / Long

Irrigation Nozzle

order code

PD-IN-D

For P200-2SMS (MS)

order code

PD-IN-2ES

For P200-2SES (ES)

order code

PD-IN-2S

For P200-2SS (S)

order code

PD-IN-2M

For P200-2SM (M)

order code

PD-IN-2L

For P200-2SL (L)

Perforator Handpiece 200 1,250 min⁻¹

The perforator handpiece for trephination. It delivers stable torque and achieves smooth and powerful cutting performance.



order code

P200-PER

Perforator Handpiece200

- Compatible Chuck: Hudson Chuck

Drill Handpiece 200 for ø2.35 mm Twist Drill 80,000 min⁻¹

The corresponding handpiece for a trephination.



order code

P200-2SD

Straight Drill Handpiece200

- Bur: ø2.35mm twist drill



Irrigation Nozzle

order code

PD-IN-D

For P200-2SD

Craniotome Handpiece 200 for ø3.17 mm bur 80,000 min⁻¹

The craniotome handpiece designed for cranial surgery. Three different types of duraguards are available for variable cranial bone thickness from pediatric to adult. The smooth and powerful cutting performance avoids adding additional stress to the surgeon.



order code

P200-CRA

Craniotome Handpiece200

- Bur: Craniotome bur, Router bur
- Bundled Item: P200-CRD-M



order code

P200-CRD-P

Pediatric Duraguard200

- Bur: Pediatric Craniotome bur, Pediatric Router bur



order code

P200-CRD-M

Medium Duraguard200

- Bur: Medium Craniotome bur, Medium Router bur



order code

P200-CRD-L

Long Duraguard200

- Bur: Long Craniotome bur, Long Router bur

Metal Cutting Handpiece 200 for ø3.17 mm bur 80,000 min⁻¹

The corresponding handpiece for cutting implants.



order code

P200-3MC

Metal Cutting Handpiece200

- Bur: Metal Cutting Carbide Bur, Metal Cutting Diamond Disc

High Torque Motor Series

High Torque : High torque motor delivers advanced cutting performance.

Versatile : Foot control and hand control options available.

Easy Maintenance : All motors and handpieces can be processed by a thermo disinfectant.

Durable : The High Torque Motor Series features a durable design as a result of NSK's long history with high precision technology. The wear-resistant coating contributes to long-lasting and scratch-free products of the high quality.



High Speed
Handpiece 200



Slim Handpiece



Super Slim
Handpiece



Standard Angled /
Straight Handpiece

Primado2 High Torque Motor



order code
P200-HMH-HS

Primado2 High Torque Motor/HS

- Hand Control type
- Speed: Max. 60,000 min⁻¹
- Available handpieces: 22 types

order code
P200-HMH

Primado2 High Torque Motor

- Speed: Max. 60,000 min⁻¹
- Available handpieces: 22 types

High Speed Handpiece 200 for $\varnothing 3.17$ mm bur 100,000 min⁻¹

The maximum rotational speed of 100,000min⁻¹ is attained by combining the High Speed Motor with a High Speed Handpiece. Its powerful cutting performance is suitable for open surgery.

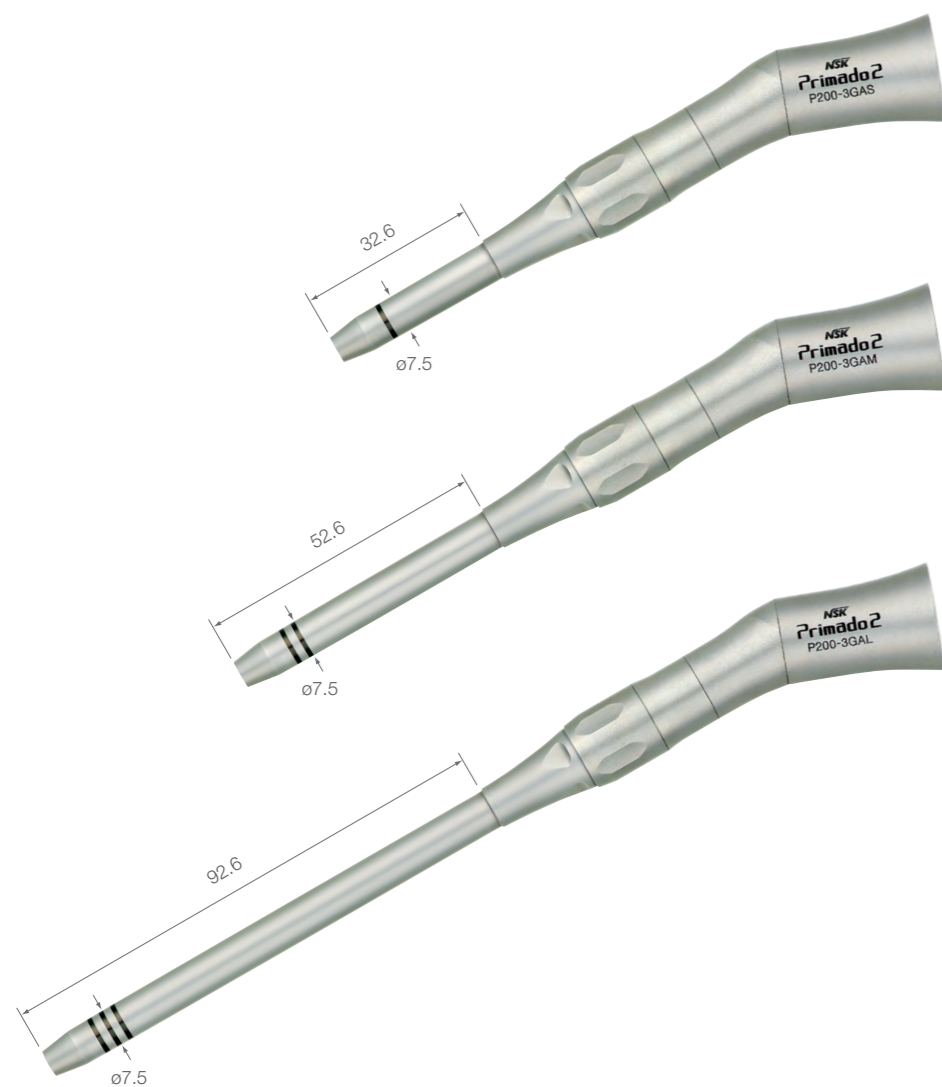

order code

P200-3GAS

High Speed Handpiece200 S

- Short type
- Bur: $\varnothing 3.17$ mm / Short

order code

P200-3GAM

High Speed Handpiece200 M

- Medium type
- Bur: $\varnothing 3.17$ mm / Medium

order code

P200-3GAL

High Speed Handpiece200 L

- Long type
- Bur: $\varnothing 3.17$ mm / Long



Irrigation Nozzle

order code

PD-IN-3S

For P200-3GAS (S)

order code

PD-IN-3M

For P200-3GAM (M)

order code

PD-IN-3L

For P200-3GAL (L)

Slim Handpiece for $\varnothing 1.0$ mm bur 60,000 min⁻¹

The Slim Handpiece has a 4.8mm diameter bur guard that delivers great visualization in endoscopic and minimally invasive spine procedures.



order code

PD-1A135

Long Slim Handpiece

- Long type
- Bur: $\varnothing 1.0$ mm / Long

order code

PD-1A155-10

Extra Long Slim Handpieces with a curvature of 10°

- Extra Long type
- Bur: $\varnothing 1.0$ mm / Extra Long

order code

PD-1A175-10

Super Long Slim Handpieces with a curvature of 10°

- Super Long type
- Bur: $\varnothing 1.0$ mm / Super Long

Super Slim Handpiece for $\varnothing 1.0$ mm bur 24,000 min⁻¹

The Super Slim Handpiece has a 2.1mm diameter bur guard. It is exclusively designed to perform the endoscopic procedure with precise and sensitive drilling of 24,000min⁻¹ at maximum in rotation speed.

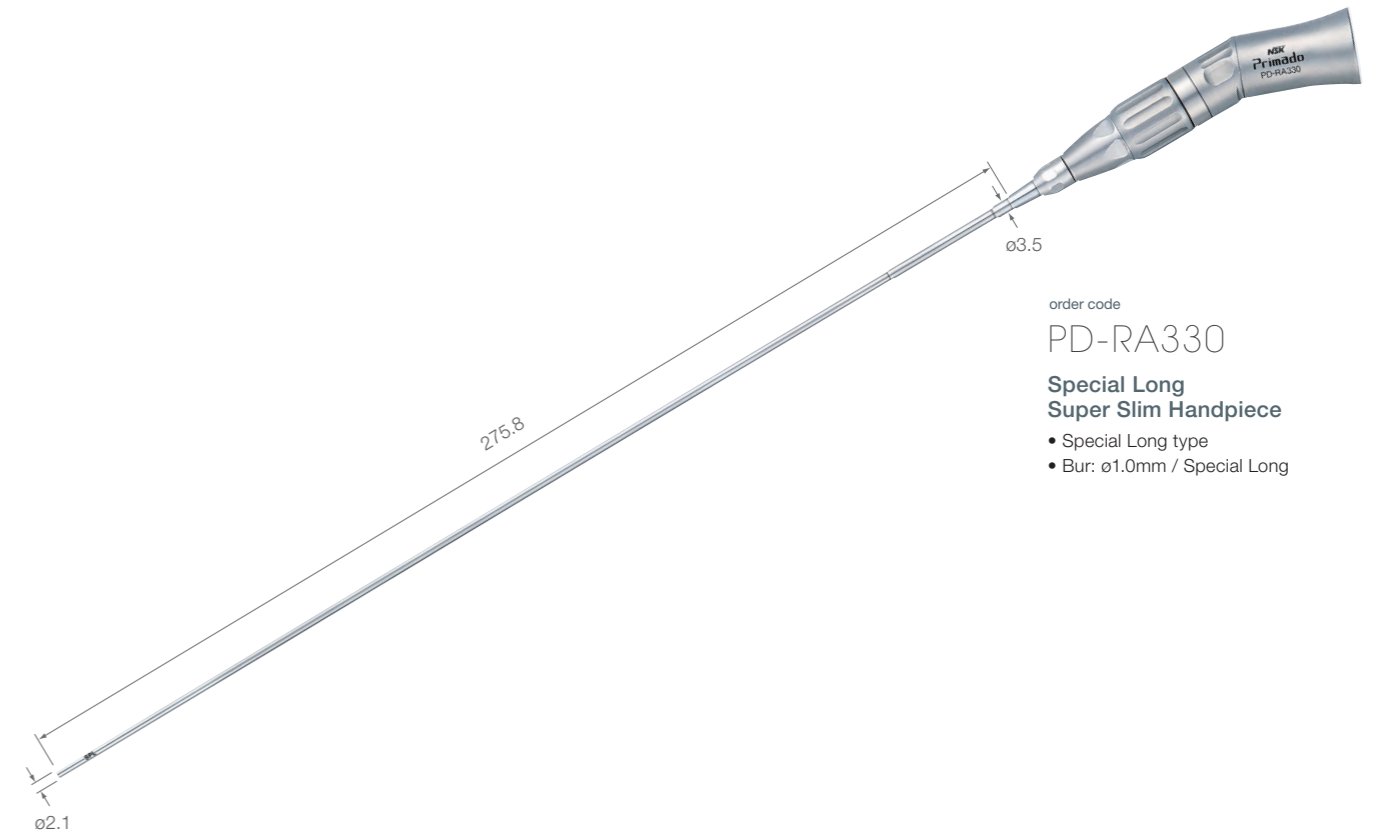

order code

PD-RA330

Special Long Super Slim Handpiece

- Special Long type
- Bur: $\varnothing 1.0$ mm / Special Long

Standard Angled Handpiece for $\varnothing 2.35$ mm bur 60,000 min⁻¹

Four different lengths of handpieces are available with the Standard Angled Handpiece to address various types of procedures. Consistent rotation and well-balanced ergonomic design relieves fatigue.

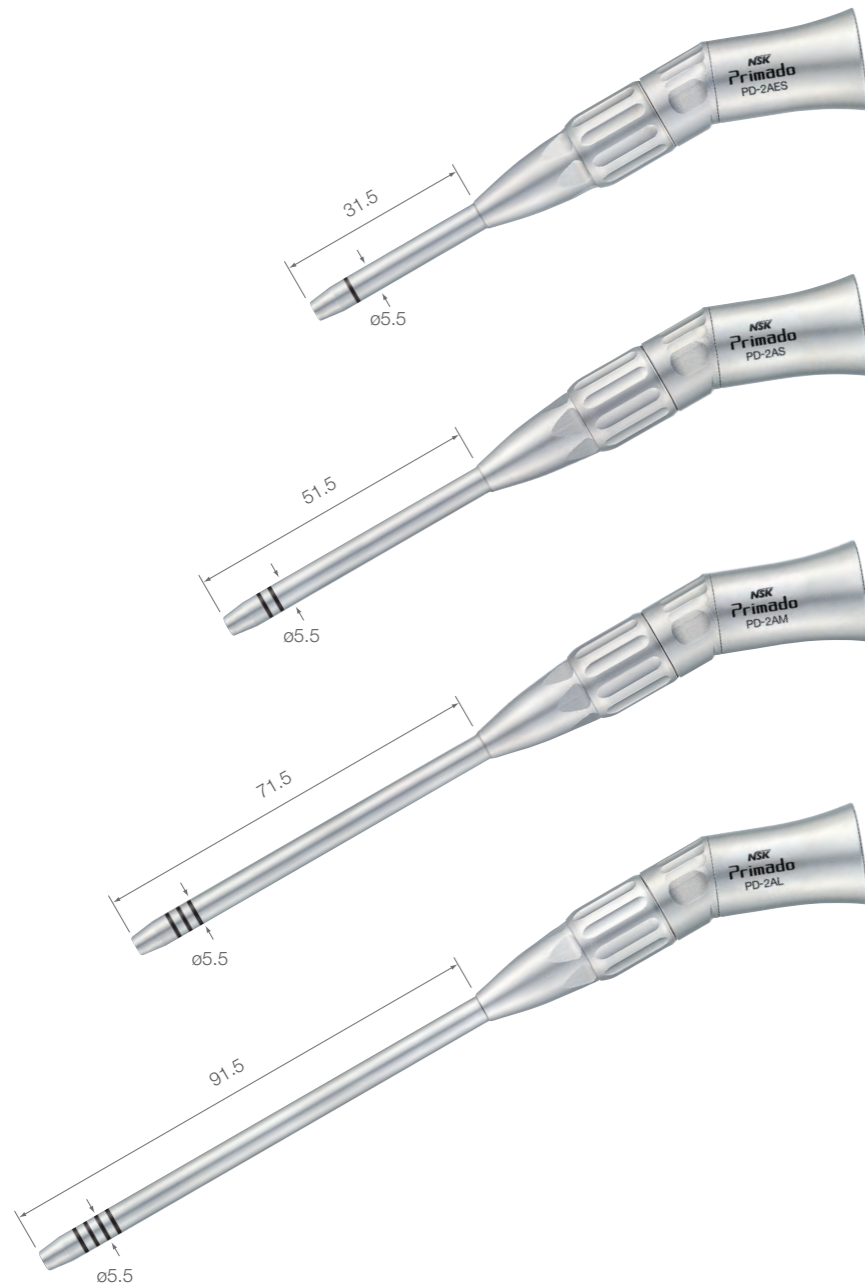

order code

PD-2AES

Extra Short Standard Angle Handpiece

- Extra Short type
- Bur: $\varnothing 2.35$ mm / Extra Short

order code

PD-2AS

Short Standard Angle Handpiece

- Short type
- Bur: $\varnothing 2.35$ mm / Short

order code

PD-2AM

Medium Standard Angle Handpiece

- Medium type
- Bur: $\varnothing 2.35$ mm / Medium

order code

PD-2AL

Long Standard Angle Handpiece

- Long type
- Bur: $\varnothing 2.35$ mm / Long



Irrigation Nozzle

order code
PD-IN-2ES
For PD-2AES (ES)

order code
PD-IN-2S
For PD-2AS (S)

order code
PD-IN-2M
For PD-2AM (M)

order code
PD-IN-2L
For PD-2AL (L)

Standard Straight Handpiece for $\varnothing 2.35$ mm bur 60,000 min⁻¹

Three different lengths of handpieces are available with the Standard Straight Handpiece to address various types of procedures. Consistent rotation and well-balanced ergonomic design relieves fatigue.

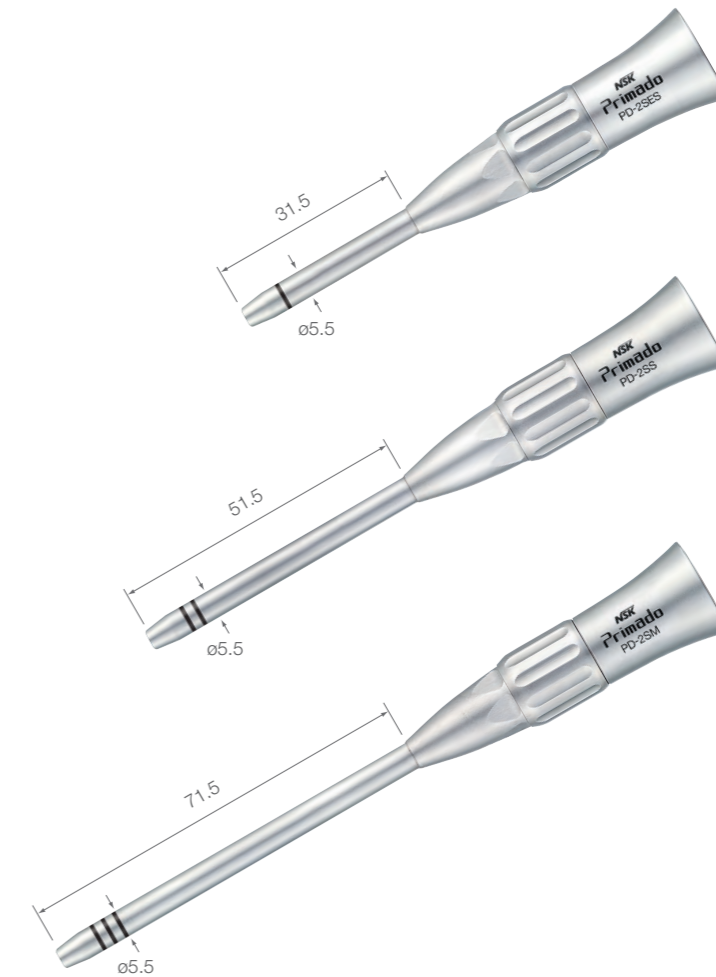

order code

PD-2SES

Extra Short Standard Straight Handpiece

- Extra Short type
- Bur: $\varnothing 2.35$ mm / Extra Short

order code

PD-2SS

Short Standard Straight Handpiece

- Short type
- Bur: $\varnothing 2.35$ mm / Short

order code

PD-2SM

Medium Standard Straight Handpiece

- Medium type
- Bur: $\varnothing 2.35$ mm / Medium



Irrigation Nozzle

order code
PD-IN-2ES
For PD-2SES (ES)

order code
PD-IN-2S
For PD-2SS (S)

order code
PD-IN-2M
For PD-2SM (M)

Perforator Handpiece 1,200 min⁻¹

The high performance handpiece for trephination. It delivers stable torque, and achieves smooth and strong cutting performance.



order code

PD-PER

Perforator Handpiece

- Compatible Chuck: Hudson Chuck

Craniotome Handpiece for ø3.17 mm bur 60,000 min⁻¹

The craniotome handpiece designed for cranial surgery. Three different types of duraguards are considered for variable cranial bone thickness from pediatric to adult. The smooth and powerful cutting performance avoids adding additional stress to the surgeon.



order code

PD-CRA

Craniotome Handpiece

- Bur: Craniotome bur, Router bur
- Bundled Item: PD-CRD-M

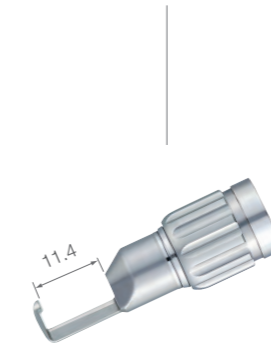

order code

PD-CRD-P

Pediatric Duraguard

- Bur: Pediatric Craniotome bur, Pediatric Router bur

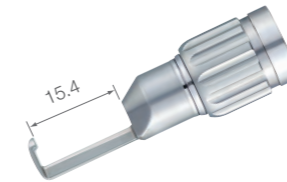

order code

PD-CRD-M

Medium Duraguard

- Bur: Medium Craniotome bur, Medium Router bur

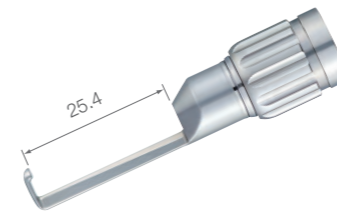

order code

PD-CRD-L

Long Duraguard

- Bur: Long Craniotome bur, Long Router bur

Drill Handpiece for $\varnothing 2.35$ mm Twist Drill 60,000 min⁻¹

The corresponding handpiece for a trephination.
The NSK Drill Handpiece is available in straight and angled models for various types of operations.



order code

PD-2SD

Straight Drill Handpiece

- Bur: $\varnothing 2.35$ mm Twist Drill

order code

PD-2SDM

Straight Drill Handpiece M

- Corresponds to $\varnothing 2.35$ mm burs

order code

PD-2AD

Angled Drill Handpiece

- Bur: $\varnothing 2.35$ mm Twist Drill

order code

PD-2ADM

Angled Drill Handpiece M

- Corresponds to $\varnothing 2.35$ mm burs



Irrigation Nozzle

order code

PD-IN-D

For PD-2SD, PD-2AD

order code

PD-IN-2ES

For PD-2SDM, PD-2ADM

Contra Angle Handpiece

The Contra Angle Handpiece is useful when approaching at a blind angle. It is available in two types of speed reduction: 16:1 and 64:1.



order code

PD-CA-16

Contra Angle Handpiece 16:1 Reduction

- 16:1 Reduction (Speed: Max. 3,750 min⁻¹)
- Latch Type Chuck
- Corresponds to $\varnothing 2.35$ mm CA burs



order code

PD-CA-64

Contra Angle Handpiece 64:1 Reduction

- 64:1 Reduction (Speed: Max. 940 min⁻¹)
- Latch Type Chuck
- Corresponds to $\varnothing 2.35$ mm CA burs

Micro Bone Saw Series

Slim Design : The streamlined lightweight design delivers well-balanced handling.

High Performance : Excellent cutting performance paired with low rotational vibration creates smooth operation.

Easy Maintenance : All motors and handpieces can be processed by a thermo disinfectant.

Durable : The Micro Bone Saw Series features a durable design as a result of NSK's long history with high precision technology. The wear-resistant coating contributes to long-lasting and scratch-free products of the highest quality.



Primado2 Reciprocating Saw Handpiece 20,000 min⁻¹



order code

P200-REC-S

Primado2 Rec. Handpiece

- Speed: Max. 20,000 min⁻¹
- Stroke Length: 2.5 mm
- Blade: Reciprocating Saw Blades, Reciprocating Rasps
- Bundled Item: P200-EZ-BM (see p.40)



order code

P200-REC-S-HS

Primado2 Rec. Handpiece/HS

- Hand Control type
- Speed: Max. 20,000 min⁻¹
- Stroke Length: 2.5 mm
- Blade: Reciprocating Saw Blades, Reciprocating Rasps
- Bundled Item: P200-EZ-BM (see p.40)

**Irrigation Nozzle**

order code

P200-IN-BS

For P200-REC-S, P200-REC-S-HS

Primado2 Sagittal Saw Handpiece 20,000 min⁻¹



order code

P200-SAG-S

Primado2 Sag. Handpiece

- Speed: Max. 20,000 min⁻¹
- Angle of Oscillation: 8°
- Blade: Sagittal and Oscillating Saw Blades
- Bundled Item: P200-EZ-BM (see p.40)



order code

P200-SAG-S-HS

Primado2 Sag. Handpiece/HS

- Hand Control type
- Speed: Max. 20,000 min⁻¹
- Angle of Oscillation: 8°
- Blade: Sagittal and Oscillating Saw Blades
- Bundled Item: P200-EZ-BM (see p.40)



Irrigation Nozzle

order code

P200-IN-BS

For P200-SAG-S, P200-SAG-S-HS

Primado2 Oscillating Saw Handpiece 20,000 min⁻¹



order code

P200-OSC-S

Primado2 Osc. Handpiece

- Speed: Max. 20,000 min⁻¹
- Angle of Oscillation: 8°
- Blade: Sagittal and Oscillation Saw Blades, Oscillating Saw Blades (for Intra Oral)
- Bundled Item: P200-EZ-BM (see p.40)



order code

P200-OSC-S-HS

Primado2 Osc. Handpiece/HS

- Hand Control type
- Speed: Max. 20,000 min⁻¹
- Angle of Oscillation: 8°
- Blade: Sagittal and Oscillation Saw Blades, Oscillating Saw Blades (for Intra Oral)
- Bundled Item: P200-EZ-BM (see p.40)



order code

PD-OSC-A

Adaptor

- Blade: Oscillating Saw Blades (for Intra Oral)
- Bundled Item: Corresponding wrench(1), and screws (2)



Irrigation Nozzle

order code

P200-IN-BS

For P200-OSC-S, P200-OSC-S-HS

Wire Pin Driver Series

Powerful : Delivers powerful pinning, wiring, and drilling through elaborate design.

Ergonomic Design : Smart design fits comfortably in the surgeon's hand and creates smooth handling and high operability.

Easy Maintenance : All motors and handpieces can be processed by a thermo disinfectant.



Wire & Pin Collet



Drill Attachment



Reamer Attachment



Saw Attachment

Primado2 Wire Pin Driver



order code

P200-WPD

Primado2 Wire Pin Driver

- Speed : Max. 1,200 min⁻¹
- Rotation Mode: Forward, Reverse, Oscillating
- Bundled Item: P200-EZ-WPD (see p.40)

Attachment for Wire Pin Driver

Wire & Pin Collet 1,200 min⁻¹



order code
PD-DA-W
Primado Wire Collet
• ø0.6-ø1.9 mm



order code
PD-DA-P
Primado Pin Collet
• ø2.0-ø3.2 mm

Drill Attachment 1,200 min⁻¹



order code
PD-DA-J4
Jacobs Keyed Drill Chuck
• ø0.5-ø4.0 mm
• Bundled Item: T wrench



order code
PD-DA-J6
Jacobs Keyed Drill Chuck
• ø0.5-ø6.5 mm
• Bundled Item: T wrench



order code
PD-DA-A
AO Drill Chuck



order code
PD-DA-K
Keyless Drill Chuck
• ø0.6-ø7.4 mm

order code
PD-TW-J4
T wrench

order code
PD-TW-J6
T wrench

Attachment for Wire Pin Driver

Reamer Attachment 300 min⁻¹



order code
PD-RA-M
Hudson Modified Trinkle Reamer



order code
PD-RA-H
Hudson Reamer



order code
PD-RA-T
Trinkle Reamer



order code
PD-RA-A
AO Reamer

Saw Attachment 12,000 min⁻¹



order code
PD-SA-R
Reciprocating Saw Attachment
• Blade: Reciprocating Saw Blades, Reciprocating Rasps



order code
PD-SA-S
Sagittal Saw Attachment
• Blade: Sagittal and Oscillating Saw Blades

Sterilization Case

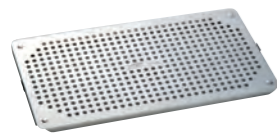

order code
SC-ML
Sterilization Metal Lid

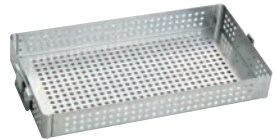

order code
SC-C-H70
Sterilization Case/H70
• Dimensions :
W512 x D262 x H70 (mm)
• Single level case

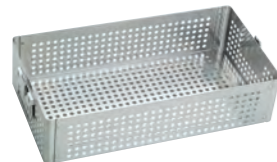

order code
SC-C-H125
Sterilization Case/H125
• Dimensions :
W512 x D262 x H125 (mm)
• Double level case

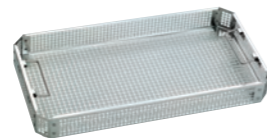

order code
SC-T-F
**Sterilization Tray
Divider-Free**
• Dimensions :
W480 x D250 x H60 (mm)



order code
SC-SM
Silicone Mat
• The mat for the Sterilization Tray

Mobile Trolley

NSK offers a specially designed mobile trolley for the Primado control unit which is not only practical but also elegant. In this way, all the equipment can be stored in one place allowing easy access when needed. The trolley has adjustable height, lockable wheels and a bracket for the cable on the side.



order code
Z299
iCart-L Mobile Trolley
• Dimensions :
W360 x D420 x H800 (mm)
• Weight : 10 kg

Irrigation Tube



order code
PD-IT-S
Surgical Irrigation Tube
• 10 pcs/ set (Sterilized)

Maintenance

PANA SPRAY Plus is a specially formulated, highly effective general handpiece lubricant. Lubricating with PANA SPRAY Plus will ensure handpiece performance and durability. Apply PANA SPRAY Plus to handpieces after "Cleaning" in the maintenance process.



order code
Z182100
PANA Spray Plus
• For Handpieces, 480 mL
• Alcohol-contained Lubricant

order code
Y900630
PANA Spray Plus (6pcs)
• Pack of 6

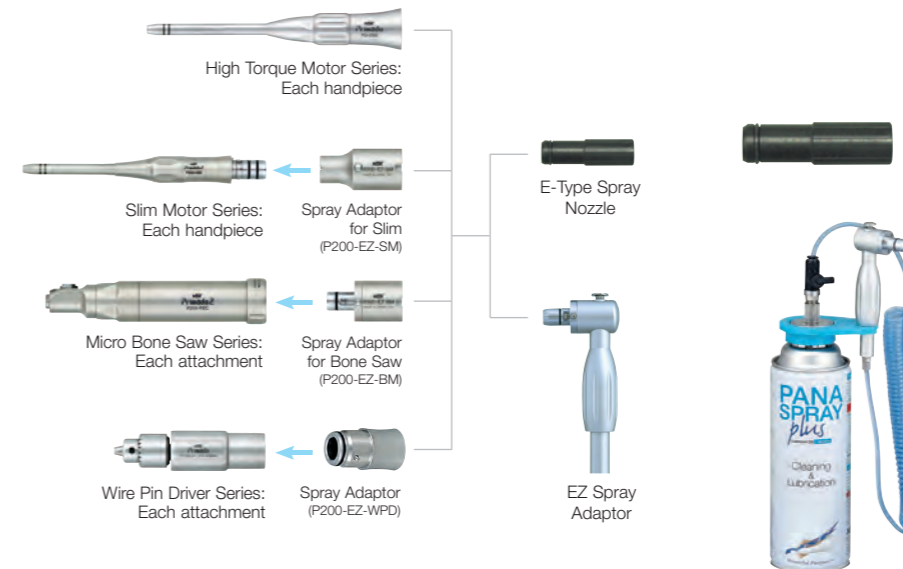

order code
Z019090
E-Type Spray Nozzle
• For Handpieces

order code
PD-EZ-M
EZ Spray Adaptor
• PANA Spray Plus is not included

Spray Mist Absorber

A convenient way to avoid mist spray from escaping into the environment. Simply insert the handpiece into the Absorber Pack then apply the spray lubricant.



order code
Y900084
Spray Mist Absorber
• Pack of 10

MEMO